

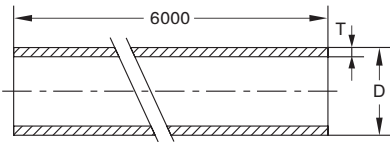

- ◆ Stainless Steel Sanitary Pipe Fitting
- ◆ Valve、Pump、Fluid Facility
- ◆ 不锈钢卫生级管件、阀门、泵、流体设备

卫生直管 Sanitary Pipe

ISO IW01



Size	DxT	A	B	R
1"	25.4x1.5			
1.25"	31.8x1.5			
1.5"	38.1x1.5			
2"	50.8x1.5			
2.5"	63.5x2.0			
3"	76.1x2.0			
3.5"	88.9x2.0			
4"	101.6x2.0			
4.5"	114.3x2.0			
5"	127.0x2.0			
6"	152.4x3.0			

焊接式弯头(90°) Welded Elbow

ISO IW02

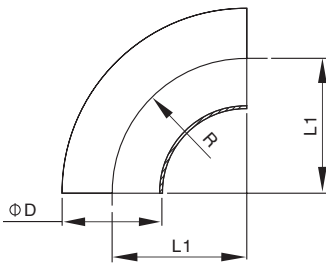

Size	DxT	L1	R
1"	25.4x1.5	33.5	33.5
1.25"	31.8x1.5	38.0	38.0
1.5"	38.1x1.5	48.5	48.5
2"	50.8x1.5	60.5	60.5
2.5"	63.5x2.0	83.5	83.5
3"	76.1x2.0	88.5	88.5
3.5"	88.9x2.0	103.5	103.5
4"	101.6x2.0	127.0	127.0
4.5"	114.3x2.0	152.4	152.4
5"	133x2.0	190.5	190.5
6"	159x3.0	228.6	228.6

卡箍式弯头(90°) Clamped Elbow

ISO IC01

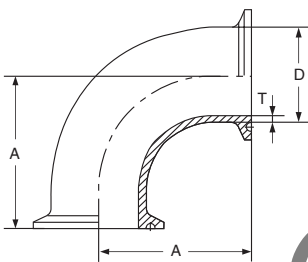

Size	DxT	A	B	C
1"	25.4x1.5	55.0		
1.25"	31.8x1.5	59.5		
1.5"	38.1x1.5	70.0		
2"	50.8x1.5	82.0		
2.5"	63.5x2.0	105.0		
3"	76.1x2.0	110.0		
3.5"	88.9x2.0	125.0		
4"	101.6x2.0	155.0		

焊式加长弯头(90°) Elbow Long

ISO IW03

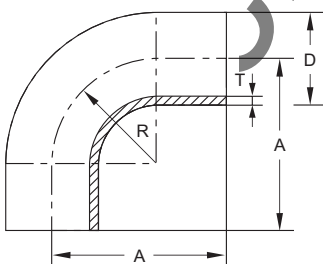

Size	DxT	A	B	R
1"	25.4x1.5	54		33.5
1.25"	31.8x1.5	60		38.0
1.5"	38.1x1.5	73		48.5
2"	50.8x1.5	85		60.5
2.5"	63.5x2.0	112		83.5
3"	76.1x2.0	116		88.5
3.5"	88.9x2.0	130		103.5
4"	101.6x2.0	160		127.0



- ◆ Stainless Steel Sanitary Pipe Fitting
- ◆ Valve、Pump、Fluid Facility
- ◆ 不锈钢卫生级管件、阀门、泵、流体设备

焊式短弯头(45°) Elbow short

ISO | IW04

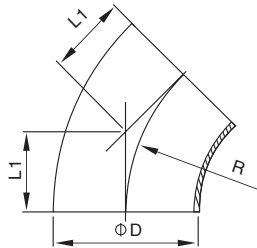

Size	DxT	L1	B	R
1"	25.4x1.5	14		33.5
1.25"	31.8x1.5	16		38.0
1.5"	38.1x1.5	20		48.5
2"	50.8x1.5	25		60.5
2.5"	63.5x2.0	35		83.5
3"	76.1x2.0	37		88.5
3.5"	88.9x2.0	43		103.5
4"	101.6x2.0	52.5		127.0
4.5"	114.3x2.0	63		152.4
5"	127.0x2.0	79		190.5
6"	152.4x2.0	94.7		228.6

卡箍式弯头(45°) Clamped Elbow

ISO | IC02

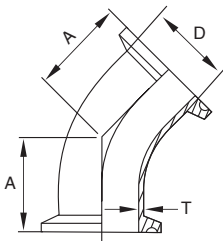

Size	DxT	A	B
1"	25.4x1.5	35.5	
1.25"	31.8x1.5	37.5	
1.5"	38.1x1.5	41.5	
2"	50.8x1.5	46.5	
2.5"	63.5x2.0	56.5	
3"	76.1x2.0	58.5	
3.5"	88.9x2.0	64.5	
4"	101.6x2.0	80.5	

焊式加长弯头(45°) Elbow Long

ISO | IW05

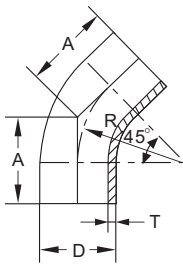

Size	DxT	A	B	R
1"	25.4x1.5	35		33.5
1.25"	31.8x1.5	38		38.0
1.5"	38.1x1.5	45		48.5
2"	50.8x1.5	50		60.5
2.5"	63.5x2.0	64		83.5
3"	76.1x2.0	70		88.5
3.5"	88.9x2.0	75		103.5
4"	101.6x2.0	86		127.0

焊式弯头(180°) Elbow

ISO | IW06

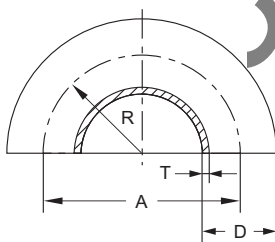

Size	DxT	A	B	R
1"	25.4x1.5	67		33.5
1.5"	38.1x1.5	97		48.5
2"	50.8x1.5	121		60.5
2.5"	63.5x2.0	167		83.5
3"	76.1x2.0	177		88.5
4"	101.6x2.0	254		127.0



- ◆ Stainless Steel Sanitary Pipe Fitting
- ◆ Valve、Pump、Fluid Facility
- ◆ 不锈钢卫生级管件、阀门、泵、流体设备

卡式弯头(180°) Clamped Elbow

ISO IC03

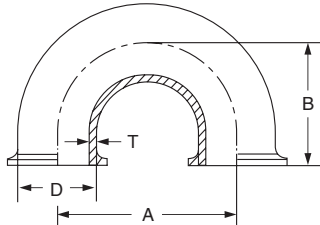

Size	DxT	A	B	R
1"	25.4x1.5	76.2	59.6	
1.5"	38.1x1.5	114.3	78.7	
2"	50.8x1.5	152.4	97.7	
2.5"	63.5x2.0	190.6	116.8	
3"	76.1x2.0	228.6	135.8	
4"	101.6x2.0	304.8	180.4	

焊式R三通 R-Tee

ISO IW07 / IW08

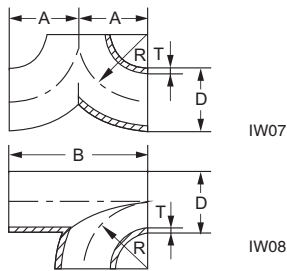

Size	DxT	A	B	R
1.5"	38.1x1.5	48.5	97	48.5
2"	50.8x1.5	60.5	121	60.5
2.5"	63.5x2.0	83.5	167	83.5
3"	76.1x2.0	88.5	177	88.5
3.5"	88.9x2.1	103.5	207	103.5
4"	101.6x2.0	127	254	127

焊式等径三通 Tee

ISO IW09 / IW10

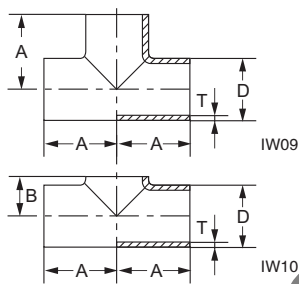

Size	DxT	A	B	R
1"	25.4x1.5	33.5	16	
1.25"	31.8x1.5	38	19	
1.5"	38.1x1.5	48.5	22	
2"	50.8x1.5	60.5	28.5	
2.5"	63.5x2.0	83.5	35	
3"	76.1x2.0	88.5	41	
3.5"	88.9x2.0	103.5	47.5	
4"	101.6x2.0	127	54	

焊式异径三通 Reducing Tee

ISO IW11 / IW12

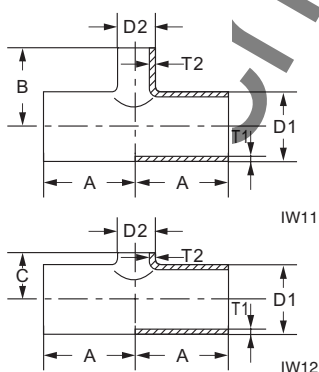

Size	D ₁ xT ₁	D ₂ xT ₂	A	B	C
1.5"x1"	38.1x1.5	25.4x1.5	48.5	44.5	22
2"x1.5"	50.8x1.5	38.1x1.5	60.5	64	28.5
2"x1"	50.8x1.5	25.4x1.5	60.5	51	28.5
2.5"x2"	63.5x2.0	50.8x1.5	83.5	82	35
2.5"x1.5"	63.5x2.0	38.1x1.5	83.5	70	35
2.5"x1"	63.5x2.0	25.4x1.5	83.5	57	35
3"x2.5"	76.1x2.0	63.5x2.0	88.5	88.5	41
3"x2"	76.1x2.0	50.8x1.5	88.5	88.5	41
3"x1.5"	76.1x2.0	38.1x1.5	88.5	76.5	41
4"x3"	101.6x2.0	76.1x2.0	127	101	54
4"x2.5"	101.6x2.0	63.5x2.0	127	101	54
4"x2"	101.6x2.0	50.8x1.5	127	101	54



- ◆ Stainless Steel Sanitary Pipe Fitting
- ◆ Valve、Pump、Fluid Facility
- ◆ 不锈钢卫生级管件、阀门、泵、流体设备

卡式等径三通 Clamped Tee

ISO | IC04 / IC05

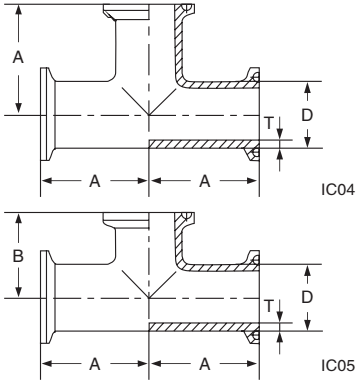

Size	DxT	A	B	C
1"	25.4x1.5	55	37.5	
1.25"	31.8x1.5	59.5	40.5	
1.5"	38.1x1.5	70	43.5	
2"	50.8x1.5	82	50	
2.5"	63.5x2.0	105	56.5	
3"	76.1x2.0	110	62.5	
3.5"	88.9x2.0	125	69	
4"	101.6x2.0	155	82	

卡式变径三通 Clamped Tee

ISO | IC06 / IC07

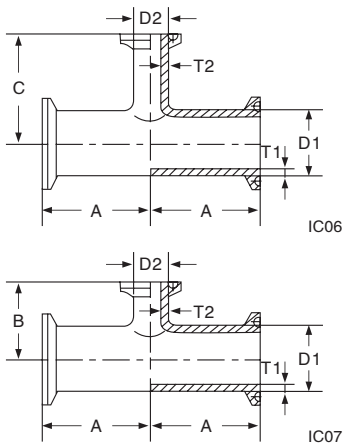

Size	D ₁ xT ₁	D ₂ xT ₂	A	B	C
1.5"x1"	38.1x1.5	25.4x1.5	70	43.5	66
2"x1.5"	50.8x1.5	38.1x1.5	82	50	85
2"x1"	50.8x1.5	25.4x1.5	82	50	72.5
2.5"x2"	63.5x2.0	50.8x1.5	105	56.5	103.5
2.5"x1.5"	63.5x2.0	38.1x1.5	105	56.5	91.5
2.5"x1"	63.5x2.0	25.4x1.5	105	56.5	78.5
3"x2.5"	76.1x2.0	63.5x2.0	110	62.5	110
3"x2"	76.1x2.0	50.8x1.5	110	62.5	110
3"x1.5"	76.1x2.0	38.1x1.5	110	62.5	98
4"x3"	101.6x2.0	76.1x2.0	155	75.5	122.5
4"x2.5"	101.6x2.0	63.5x2.0	155	75.5	122.5
4"x2"	101.6x2.0	50.8x1.5	155	75.5	122.5

焊接式四通 Welded Cross

ISO | IW13

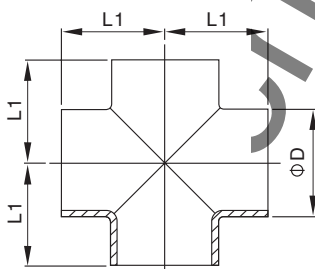

Size	DxT	L1	B	C
1"	25.4x1.5	33.5		
1.25"	31.8x1.5	38.0		
1.5"	38.1x1.5	48.5		
2"	50.8x1.5	60.5		
2.5"	63.5x2.0	83.5		
3"	76.1x2.0	88.5		
3.5"	88.9x2.0	103.5		
4"	101.6x2.0	127.0		
4.5"	114.3x2.0	152.4		



- ◆ Stainless Steel Sanitary Pipe Fitting
- ◆ Valve、Pump、Fluid Facility
- ◆ 不锈钢卫生级管件、阀门、泵、流体设备

焊接式四通 Welded Cross

ISO IW14

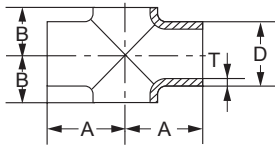

Size	DxT	A	B	C
1"	25.4x1.5	33.5	16	
1.25"	31.8x1.5	38.0	19	
1.5"	38.1x1.5	48.5	22	
2"	50.8x1.5	60.5	28.5	
2.5"	63.5x2.0	83.5	35	
3"	76.1x2.0	88.5	41	
3.5"	88.9x2.0	103.5	47.5	
4"	101.6x2.0	127.0	54	
4.5"	114.3x2.0	152.4	60	

卡式四通 Clamped Cross

ISO IC08

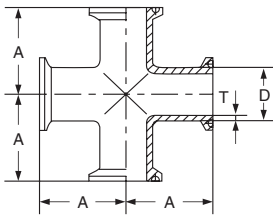

Size	DxT	A	B	C
1"	25.4x1.5	55		
1.25"	31.8x1.5	59.5		
1.5"	38.1x1.5	70		
2"	50.8x1.5	82		
2.5"	63.5x2.0	105		
3"	76.1x2.0	110		
3.5"	88.9x2.0	125		
4"	101.6x2.0	155		

焊接式大小头 Welded Reducer

ISO IW15 / IW16

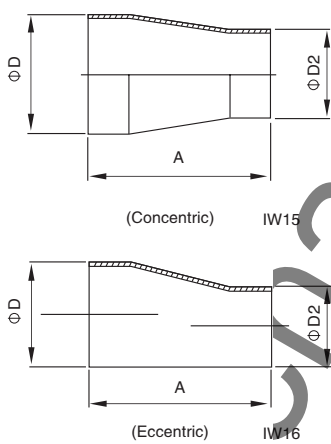

Size	A	D	D2
1.0"/0.75"	38	38.1	25.4
1.25"/1.0"	50	50.8	25.4
1.5"/1.25"	50	50.8	38.1
1.5"/1.0"	50	63.5	25.4
2.0"/1.5"	67	63.5	38.1
2.0"/1.25"	67	63.5	50.8
2.0"/1.0"	67	76.2	25.4
2.5"/2.0"	67	76.2	38.1
2.5"/1.5"	67	76.2	50.8
2.5"/1.0"	67	76.2	63.5
3.0"/2.5"	67	101.6	25.4
3.0"/2.0"	67	101.6	38.1
3.0"/1.5"	67	101.6	50.8
3.5"/3.0"	76	101.6	63.5
3.5"/2.5"	67	101.6	76.2
3.5"/2.0"	67	101.6	25.4
4.0"/3.5"	87	101.6	38.1
4.0"/3.0"	87	101.6	50.8
4.0"/2.5"	87	101.6	63.5
4.0"/2.0"	87	101.6	76.2



- ◆ Stainless Steel Sanitary Pipe Fitting
- ◆ Valve、Pump、Fluid Facility
- ◆ 不锈钢卫生级管件、阀门、泵、流体设备

卡箍式大小头 Clamped Reducer

ISO IC09 / IC10

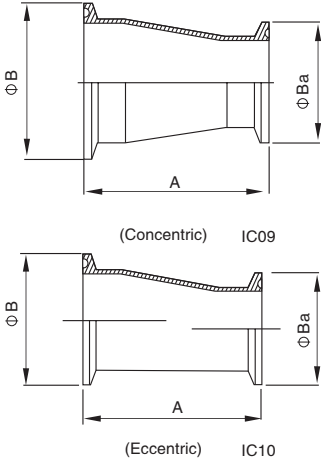

Size	A	B	Ba		
1.0"/0.75"	64	50.5	34.0		
1.25"/1.0"	76	50.5	50.5		
1.5"/1.25"	76	50.5	50.5		
1.5"/1.0"	76	50.5	50.5		
2.0"/1.5"	93	64.0	50.5		
2.0"/1.25"	93	64.0	50.5		
2.0"/1.0"	93	64.0	50.5		
2.5"/2.0"	93	77.5	64.0		
2.5"/1.5"	93	77.5	50.5		
2.5"/1.0"	93	77.5	50.5		
3.0"/2.5"	93	91.0	77.5		
3.0"/2.0"	93	91.0	64.0		
3.0"/1.5"	93	91.0	50.5		
3.5"/3.0"	93	106.0	91.0		
3.5"/2.5"	93	106.0	77.5		
3.5"/2.0"	93	106.0	64.0		
4.0"/3.5"	118	119.0	106.0		
4.0"/3.0"	118	119.0	91.0		
4.0"/2.5"	118	119.0	77.5		
4.0"/2.0"	118	119.0	64.0		

maofei valve



- ◆ Stainless Steel Sanitary Pipe Fitting
- ◆ Valve、Pump、Fluid Facility
- ◆ 不锈钢卫生级管件、阀门、泵、流体设备

卫生直管 Sanitary Pipe

DIN DW01

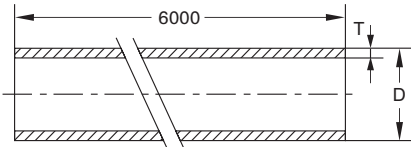

Size	DxT	A	R		
DN10	12x1.5				
DN15	18x1.5				
DN20	22x1.5				
DN25	28x1.5				
DN32	34x1.5				
DN40	40x1.5				
DN50	52x1.5				
DN65	70x2.0				
DN80	85x2.0				
DN100	104x2.0				
DN125	129x2.0				
DN150	154x2.0				
DN200	204x2.0				
DN250	254x2.0				

焊接式短弯头(90°) Welded Elbow

DIN DW02

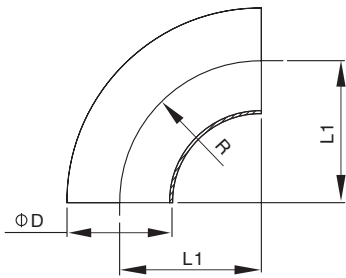

Size	DxT	L1	R		
DN10	12x1.5	26.0	26.0		
DN15	18x1.5	35.0	35.0		
DN20	22x1.5	40.0	40.0		
DN25	28x1.5	50.0	50.0		
DN32	34x1.5	55.0	55.0		
DN40	40x1.5	60.0	60.0		
DN50	52x1.5	70.0	70.0		
DN65	70x2.0	80.0	80.0		
DN80	85x2.0	90.0	90.0		
DN100	104x2.0	100.0	100.0		
DN125	129x2.0	187.5	187.5		
DN150	154x2.0	225.0	225.0		

加直端焊接式弯头(90°) Elbow Long

DIN DW03

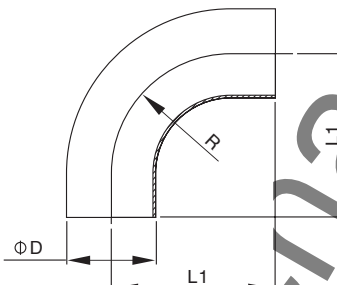

Size	DxT	L1	R		
DN10	12x1.5	38.0	26.0		
DN15	18x1.5	47.0	35.0		
DN20	22x1.5	52.0	40.0		
DN25	28x1.5	70.0	50.0		
DN32	34x1.5	78.0	55.0		
DN40	40x1.5	85.0	60.0		
DN50	52x1.5	97.0	70.0		
DN65	70x2.0	110.0	80.0		
DN80	85x2.0	118.0	90.0		
DN100	104x2.0	140.0	100.0		



- ◆ Stainless Steel Sanitary Pipe Fitting
- ◆ Valve、Pump、Fluid Facility
- ◆ 不锈钢卫生级管件、阀门、泵、流体设备

卡箍式弯头(90°) Clamped Elbow

DIN | DC01

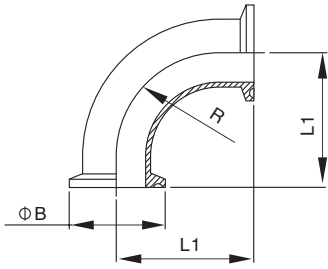

Size	L1	R	B		
DN15	53.0	34.0	35.0		
DN20	58.0	34.0	40.0		
DN25	71.0	50.5	50.0		
DN32	76.5	50.5	55.0		
DN40	81.5	50.5	60.0		
DN50	91.5	64.0	70.0		
DN65	108.5	91.0	80.0		
DN80	118.0	106.0	90.0		
DN100	128.0	119.0	100.0		

活接式弯头(90°) Union-type Elbow

DIN | DQ01

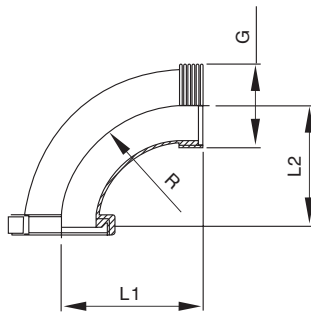

Size	L1	L2	G	R		
DN20	60.0	55.0	RD44x1/6	40.0		
DN25	71.0	67.0	RD52x1/6	50.0		
DN32	76.0	72.0	RD58x1/6	55.0		
DN40	81.0	77.0	RD65x1/6	60.0		
DN50	91.0	87.0	RD78x1/6	70.0		
DN65	103.0	97.0	RD95x1/6	80.0		
DN80	116.0	110.0	RD110x1/4	90.0		
DN100	128.0	124.0	RD130x1/4	100.0		

焊接式弯头(45°) Welded Elbow

DIN | DW04

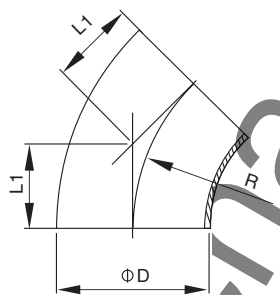

Size	DxT	L1	R		
DN10	12x1.5	10.7	26.0		
DN15	18x1.5	14.5	35.0		
DN20	22x1.5	16.5	40.0		
DN25	28x1.5	20.7	50.0		
DN32	34x1.5	22.8	55.0		
DN40	40x1.5	24.8	60.0		
DN50	52x1.5	29.0	70.0		
DN65	70x2.0	33.2	80.0		
DN80	85x2.0	37.3	90.0		
DN100	104x2.0	41.5	100.0		
DN125	129x2.0	77.5	187.5		
DN150	154x2.0	93.2	225.0		

SANITARY PIPE FITTINGS 卫生级管件



- ◆ Stainless Steel Sanitary Pipe Fitting
- ◆ Valve、Pump、Fluid Facility
- ◆ 不锈钢卫生级管件、阀门、泵、流体设备

卡箍式弯头(45°) Clamped Elbow

DIN | DC02

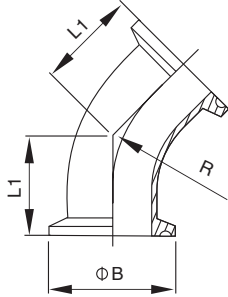

Size	L1	B	R		
DN20	34.5	34.0	40.0		
DN25	42.2	50.5	50.0		
DN32	44.3	50.5	55.0		
DN40	46.3	50.5	60.0		
DN50	50.5	64.0	70.0		
DN65	61.2	91.0	80.0		
DN80	65.3	106.0	90.0		
DN100	69.5	119.0	100.0		

焊接式弯头(180°) Welded Elbow

DIN | DW05

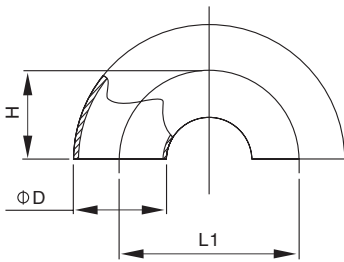

Size	DxT	L1	H		
DN10	12x1.5	52.0	26.0		
DN15	18x1.5	70.0	35.0		
DN20	22x1.5	80.0	40.0		
DN25	28x1.5	100.0	50.0		
DN32	34x1.5	110.0	55.0		
DN40	40x1.5	120.0	60.0		
DN50	52x1.5	140.0	70.0		
DN65	70x2.0	160.0	80.0		
DN80	85x2.0	180.0	90.0		
DN100	104x2.0	200.0	100.0		
DN125	129x2.0	375.0	187.5		
DN150	154x2.0	450.0	225.0		

焊式R三通 R-Tee

DIN | DW06

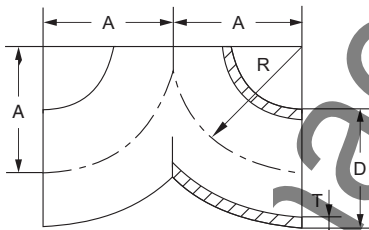

Size	DxT	A	R		
DN10	12x1.5	26.0	26.0		
DN15	18x1.5	35.0	35.0		
DN20	22x1.5	40.0	40.0		
DN25	28x1.5	50.0	50.0		
DN32	34x1.5	55.0	55.0		
DN40	40x1.5	60.0	60.0		
DN50	52x1.5	70.0	70.0		
DN65	70x2.0	80.0	80.0		
DN80	85x2.0	90.0	90.0		
DN100	104x2.0	100.0	100.0		
DN125	129x2.0	187.5	187.5		
DN150	154x2.0	225.0	225.0		
DN200	204x2.0	300.0	300.0		
DN250	254x2.0	375.0	375.0		



- ◆ Stainless Steel Sanitary Pipe Fitting
- ◆ Valve、Pump、Fluid Facility
- ◆ 不锈钢卫生级管件、阀门、泵、流体设备

焊式R三通 R-Tee

DIN DW07

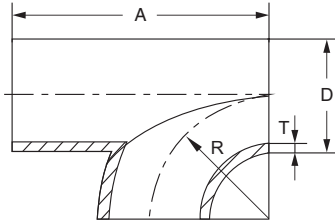

Size	DxT	A	R
DN10	12x1.5	52.0	26.0
DN15	18x1.5	70.0	35.0
DN20	22x1.5	80.0	40.0
DN25	28x1.5	100.0	50.0
DN32	34x1.5	110.0	55.0
DN40	40x1.5	120.0	60.0
DN50	52x1.5	140.0	70.0
DN65	70x2.0	160.0	80.0
DN80	85x2.0	180.0	90.0
DN100	104x2.0	200.0	100.0
DN125	129x2.0	375.0	187.5
DN150	154x2.0	450.0	225.0
DN200	204x2.0	600.0	300.0
DN250	254x2.0	750.0	375.0

短型焊接式三通 Short welded Tee

DIN DW08

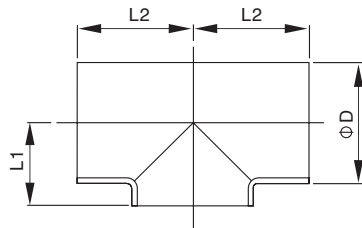

Size	DxT	L1	L2
DN10	12x1.5	7.5	26.0
DN15	18x1.5	10.5	35.0
DN20	22x1.5	12.5	40.0
DN25	28x1.5	16.0	50.0
DN32	34x1.5	19.5	55.0
DN40	40x1.5	22.5	60.0
DN50	52x1.5	30.0	70.0
DN65	70x2.0	39.5	80.0
DN80	85x2.0	47.5	90.0
DN100	104x2.0	58.0	100.0
DN125	129x2.0	70.5	187.5
DN150	154x2.0	83.0	225.0

长型焊接式三通 Long welded Tee

DIN DW09

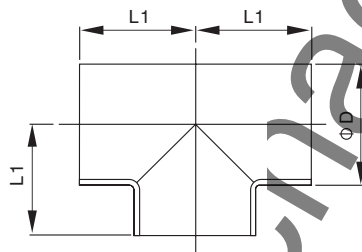

Size	DxT	L1
DN10	12x1.5	26.0
DN15	18x1.5	35.0
DN20	22x1.5	40.0
DN25	28x1.5	50.0
DN32	34x1.5	55.0
DN40	40x1.5	60.0
DN50	52x1.5	70.0
DN65	70x2.0	80.0
DN80	85x2.0	90.0
DN100	104x2.0	100.0
DN125	129x2.0	187.5
DN150	154x2.0	225.0

SANITARY PIPE FITTINGS 卫生级管件



- ◆ Stainless Steel Sanitary Pipe Fitting
- ◆ Valve、Pump、Fluid Facility
- ◆ 不锈钢卫生级管件、阀门、泵、流体设备

卡箍式三通 Clamped Tee

DIN DC03

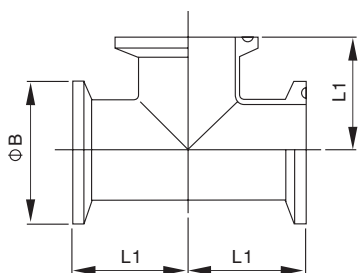

Size	L1	B			
DN15	53.0	34.0			
DN20	58.0	34.0			
DN25	71.5	50.5			
DN32	76.5	50.5			
DN40	81.5	50.5			
DN50	91.5	64.0			
DN65	108.0	91.0			
DN80	118.0	106.0			
DN100	128.0	119.0			

变径三通 Reducing Tee

DIN DW10

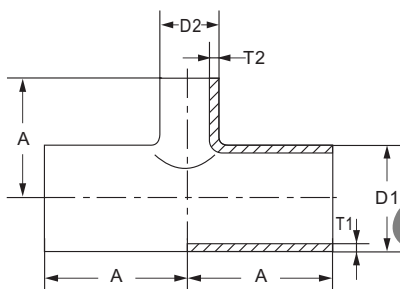

Size	D ₁ xT ₁	D ₂ xT ₂	A		
DN25/20	28x1.5	22x1.5	50.0		
DN32/25	34x1.5	28x1.5	55.0		
DN40/25	40x1.5	28x1.5	60.0		
DN40/32	40x1.5	34x1.5	60.0		
DN50/25	52x1.5	28x1.5	70.0		
DN50/40	52x1.5	40x1.5	70.0		
DN65/25	70x2.0	28x1.5	80.0		
DN65/40	70x2.0	40x1.5	80.0		
DN65/50	70x2.0	52x1.5	80.0		
DN80/25	85x2.0	28x1.5	90.0		
DN80/40	85x2.0	40x1.5	90.0		
DN80/50	85x2.0	52x1.5	90.0		
DN80/65	85x2.0	70x2.0	90.0		
DN100/25	104x2.0	28x1.5	100.0		
DN100/40	104x2.0	40x1.5	100.0		
DN100/50	104x2.0	52x1.5	100.0		
DN100/65	104x2.0	70x2.0	100.0		
DN100/80	104x2.0	85x2.0	100.0		
DN125/25	129x2.0	28x1.5	187.5		
DN125/40	129x2.0	40x1.5	187.5		
DN125/50	129x2.0	52x1.5	187.5		
DN125/65	129x2.0	70x2.0	187.5		
DN125/80	129x2.0	85x2.0	187.5		
DN125/100	129x2.0	104x2.0	187.5		
DN150/25	154x2.0	28x1.5	225.0		
DN150/40	154x2.0	40x1.5	225.0		
DN150/50	154x2.0	52x1.5	225.0		
DN150/65	154x2.0	70x2.0	225.0		
DN150/80	154x2.0	85x2.0	225.0		
DN150/100	154x2.0	104x2.0	225.0		
DN150/125	154x2.0	129x2.0	225.0		



- ◆ Stainless Steel Sanitary Pipe Fitting
- ◆ Valve、Pump、Fluid Facility
- ◆ 不锈钢卫生级管件、阀门、泵、流体设备

变径短三通 Reducing Tee Short

DIN DW11

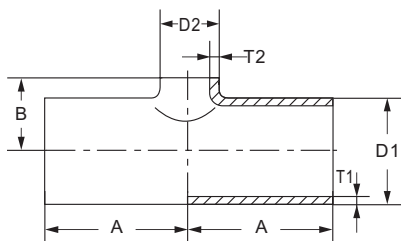

Size	D ₁ xT ₁	D ₂ xT ₂	A	B
DN25/20	28x1.5	22x1.5	50.0	16
DN32/25	34x1.5	28x1.5	55.0	20.5
DN40/25	40x1.5	28x1.5	60.0	23.5
DN40/32	40x1.5	34x1.5	60.0	23
DN50/25	52x1.5	28x1.5	70.0	29
DN50/40	52x1.5	40x1.5	70.0	29
DN65/25	70x2.0	28x1.5	80.0	38
DN65/40	70x2.0	40x1.5	80.0	39.5
DN65/50	70x2.0	52x1.5	80.0	39
DN80/25	85x2.0	28x1.5	90.0	45.5
DN80/40	85x2.0	40x1.5	90.0	46.5
DN80/50	85x2.0	52x1.5	90.0	47
DN80/65	85x2.0	70x2.0	90.0	47
DN100/25	104x2.0	28x1.5	100.0	56
DN100/40	104x2.0	40x1.5	100.0	56
DN100/50	104x2.0	52x1.5	100.0	58
DN100/65	104x2.0	70x2.0	100.0	58
DN100/80	104x2.0	85x2.0	100.0	59
DN125/25	129x2.0	28x1.5	187.5	69.5
DN125/40	129x2.0	40x1.5	187.5	69.5
DN125/50	129x2.0	52x1.5	187.5	69.5
DN125/65	129x2.0	70x2.0	187.5	72.5
DN125/80	129x2.0	85x2.0	187.5	72.5
DN125/100	129x2.0	104x2.0	187.5	69.5
DN150/25	154x2.0	28x1.5	225.0	82
DN150/40	154x2.0	40x1.5	225.0	82
DN150/50	154x2.0	52x1.5	225.0	82
DN150/65	154x2.0	70x2.0	225.0	82
DN150/80	154x2.0	85x2.0	225.0	82
DN150/100	154x2.0	104x2.0	225.0	87
DN150/125	154x2.0	129x2.0	225.0	82

等径四通 Cross

DIN DW12

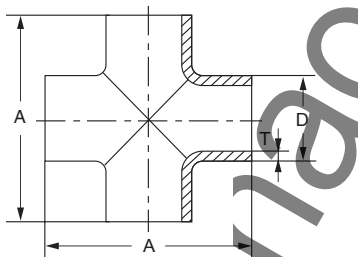

Size	DxT	A	B	C
DN25	28x1.5	100.0		
DN32	34x1.5	110.0		
DN40	40x1.5	120.0		
DN50	52x1.5	140.0		
DN65	70x2.0	160.0		
DN80	85x2.0	180.0		
DN100	104x2.0	200.0		
DN125	129x2.0	375.0		
DN150	154x2.0	450.0		
DN200	204x2.0	600.0		
DN250	254x2.0	750.0		



- ◆ Stainless Steel Sanitary Pipe Fitting
- ◆ Valve、Pump、Fluid Facility
- ◆ 不锈钢卫生级管件、阀门、泵、流体设备

等径短四通 Cross Short

DIN DW13

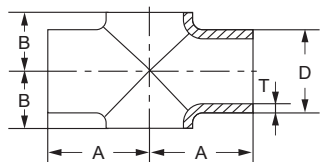

Size	DxT	A	B	C
DN25	28x1.5	50.0	15.5	
DN32	34x1.5	55.0	19.0	
DN40	40x1.5	60.0	23.0	
DN50	52x1.5	70.0	31.0	
DN65	70x2.0	80.0	41.0	
DN80	85x2.0	90.0	48.5	
DN100	104x2.0	100.0	58.0	
DN125	129x2.0	187.5	74.0	
DN150	154x2.0	225.0	90.0	
DN200	204x2.0	300.0	115.0	
DN250	254x2.0	375.0	140.0	

焊接式大小头 Welded Reducer

DIN DW14 / DW15

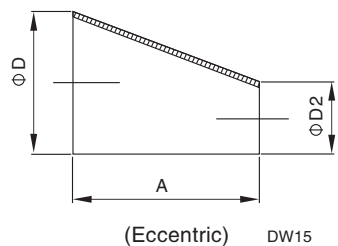
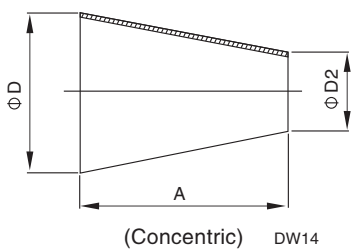

Size	A	D	D2
DN20/15	7.0	22.0	18.0
DN25/20	11.0	28.0	22.0
DN32/20	22.0	34.0	22.0
DN32/25	11.0	34.0	28.0
DN40/20	33.0	40.0	22.0
DN40/25	22.0	40.0	28.0
DN40/32	11.0	40.0	34.0
DN50/25	44.0	52.0	28.0
DN50/32	33.0	52.0	34.0
DN50/40	22.0	52.0	40.0
DN65/25	73.0	70.0	28.0
DN65/32	62.0	70.0	34.0
DN65/40	51.0	70.0	40.0
DN65/50	29.0	70.0	52.0
DN80/40	78.0	85.0	40.0
DN80/50	56.0	85.0	52.0
DN80/65	27.0	85.0	70.0
DN100/50	90.0	104.0	52.0
DN100/65	61.0	104.0	70.0
DN100/80	34.0	104.0	85.0



- ◆ Stainless Steel Sanitary Pipe Fitting
- ◆ Valve、Pump、Fluid Facility
- ◆ 不锈钢卫生级管件、阀门、泵、流体设备

焊接式大小头 Welded Reducer

DIN | DW15 / DW16

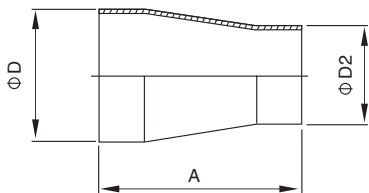

(Concentric) DW15

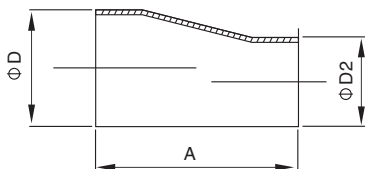

(Eccentric) DW16

Size	A	D	D2
DN20/15	60.0	22.0	18.0
DN25/20	60.0	28.0	22.0
DN32/20	80.0	34.0	22.0
DN32/25	80.0	34.0	28.0
DN40/20	102.0	40.0	22.0
DN40/25	102.0	40.0	28.0
DN40/32	102.0	40.0	34.0
DN50/25	115.0	52.0	28.0
DN50/32	115.0	52.0	34.0
DN50/40	115.0	52.0	40.0
DN65/25	125.0	70.0	28.0
DN65/32	125.0	70.0	34.0
DN65/40	120.0	70.0	40.0
DN65/50	120.0	70.0	52.0
DN80/40	140.0	85.0	40.0
DN80/50	125.0	85.0	52.0
DN80/65	120.0	85.0	70.0
DN100/50	160.0	104.0	52.0
DN100/65	127.0	104.0	70.0
DN100/80	120.0	104.0	85.0

卡箍式大小头 Clamped Reducer

DIN | DC04 / DC05

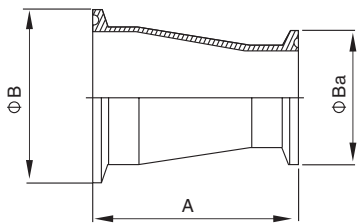

(Concentric) DC04

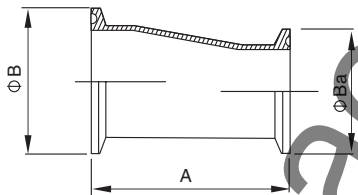

(Eccentric) DC05

Size	A	B	Ba
DN20/15	86.0	34.0	34.0
DN25/20	86.0	50.5	34.0
DN32/20	106.0	50.5	34.0
DN32/25	106.0	50.5	50.5
DN40/20	128.0	50.5	34.0
DN40/25	128.0	50.5	50.5
DN40/32	128.0	50.5	50.5
DN50/25	141.0	64.0	50.5
DN50/32	141.0	64.0	50.5
DN50/40	141.0	64.0	50.5
DN65/25	151.0	91.0	50.5
DN65/32	151.0	91.0	50.5
DN65/40	146.0	91.0	50.5
DN65/50	146.0	91.0	64.0
DN80/40	166.0	106.0	50.5
DN80/50	151.0	106.0	64.0
DN80/65	146.0	106.0	91.0
DN100/50	192.0	119.0	64.0
DN100/65	159.0	119.0	91.0
DN100/80	152.0	119.0	106.0



- ◆ Stainless Steel Sanitary Pipe Fitting
- ◆ Valve、Pump、Fluid Facility
- ◆ 不锈钢卫生级管件、阀门、泵、流体设备

由任式大小头 Union-type Reducer

DIN | DQ02 / DQ03

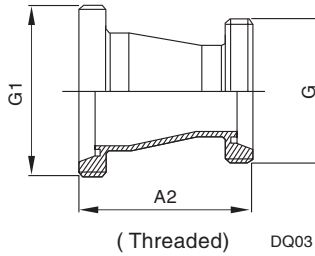
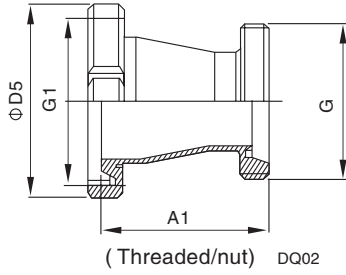

Size	A1	G	D5	A2	G1
DN20/15	93.0	RD34x1/8	54.0	98.0	RD44x1/6
DN25/20	97.0	RD44x1/6	62.0	101.0	RD52x1/6
DN32/20	117.0	RD44x1/6	68.0	121.0	RD58x1/6
DN32/25	118.0	RD52x1/6	68.0	122.0	RD58x1/6
DN40/20	139.0	RD44x1/6	78.0	143.0	RD65x1/6
DN40/25	140.0	RD52x1/6	78.0	144.0	RD65x1/6
DN40/32	140.0	RD58x1/6	78.0	144.0	RD65x1/6
DN50/25	153.0	RD52x1/6	92.0	157.0	RD78x1/6
DN50/32	153.0	RD58x1/6	92.0	157.0	RD78x1/6
DN50/40	153.0	RD65x1/6	92.0	157.0	RD78x1/6
DN65/25	163.0	RD52x1/6	110.0	169.0	RD95x1/6
DN65/32	163.0	RD58x1/6	110.0	169.0	RD95x1/6
DN65/40	158.0	RD65x1/6	110.0	164.0	RD95x1/6
DN65/50	158.0	RD78x1/6	110.0	164.0	RD95x1/6
DN80/40	181.0	RD65x1/6	126.0	187.0	RD110x1/4
DN80/50	166.0	RD78x1/6	126.0	172.0	RD110x1/4
DN80/65	183.0	RD95x1/6	126.0	174.0	RD110x1/4
DN100/50	195.0	RD78x1/6	146.0	209.0	RD130x1/4
DN100/65	174.0	RD95x1/6	146.0	178.0	RD130x1/4
DN100/80	170.0	RD110x1/4	146.0	174.0	RD130x1/4

maofei valve



- ◆ Stainless Steel Sanitary Pipe Fitting
- ◆ Valve、 Pump、 Fluid Facility
- ◆ 不锈钢卫生级管件、阀门、泵、流体设备

卫生直管 Sanitary Pipe

SMS | SW01

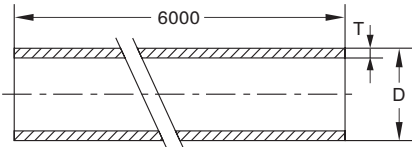

Size	DxT	A	B	C
1"	25.4x1.2			
1.5"	38.1x1.2			
2"	50.8x1.2			
2.5"	63.5x1.6			
3"	76.2x1.6			
4"	101.6x2.0			

焊接式弯头(90°) Welded Elbow

SMS | SW02

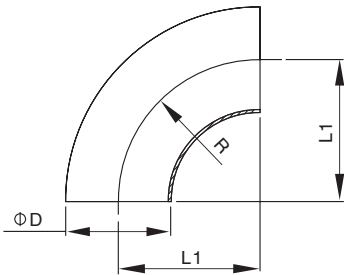

Size	DxT	L1	R
1"	25.4x1.2	38.1	38.1
1.25"	31.8x1.2	47.7	47.7
1.5"	38.1x1.2	57.1	57.1
2"	50.8x1.2	76.2	76.2
2.5"	63.5x1.6	95.2	95.2
3"	76.2x1.6	114.3	114.3
4"	101.6x2.0	152.4	152.4

焊式加长弯头(90°) Elbow long

SMS | SW03

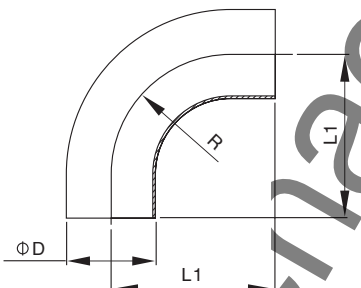

Size	DxT	L1	R
1"	25.4x1.2	55	25
1.5"	38.1x1.2	70	38
2"	50.8x1.2	82	51
2.5"	63.5x1.6	105	63.5
3"	76.2x1.6	110	76
4"	101.6x2.0	160	127

SANITARY PIPE FITTINGS 卫生级管件



- ◆ Stainless Steel Sanitary Pipe Fitting
- ◆ Valve、Pump、Fluid Facility
- ◆ 不锈钢卫生级管件、阀门、泵、流体设备

短型焊接式弯头(45°) Short welded Elbow

SMS | SW04

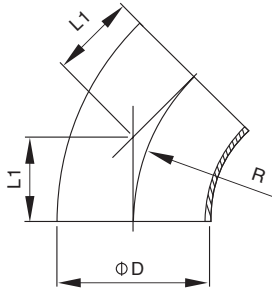

Size	DxT	L1	R		
1"	25.4x1.2	15.5	38.1		
1.5"	38.1x1.2	23.6	57.2		
2"	50.8x1.2	31.6	76.2		
2.5"	63.5x1.6	39.5	95.3		
3"	76.2x1.6	47.2	114.3		
4"	101.6x2.0	63	152.4		

焊式加长弯头(45°) Elbow Long

SMS | SW05

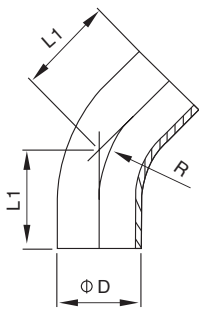

Size	DxT	L1	R		
1"	25.4x1.2	42.5	38.7		
1.5"	38.1x1.2	56.8	57.2		
2"	50.8x1.2	68.6	76.2		
2.5"	63.5x1.6	78.4	95.3		
3"	76.2x1.6	85.2	114.3		
4"	101.6x2.0	103	152.4		

短型焊接式三通 Short welded Tee

SMS | SW06

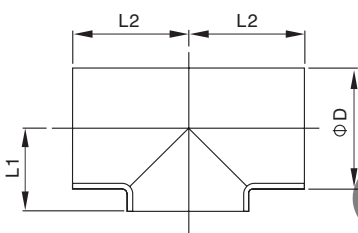

Size	DxT	L1	L2		
1"	25.4x1.2	15	55		
1.5"	38.1x1.2	21.5	70		
2"	50.8x1.2	29	82		
2.5"	63.5x1.6	36	105		
3"	76.2x1.6	43	110		
4"	101.6x2.0	57	150		

长型焊接式三通 Long welded Tee

SMS | SW07

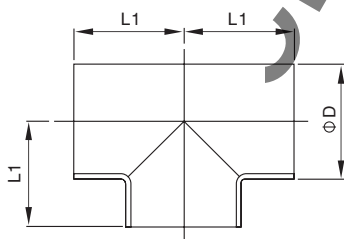

Size	DxT	L1			
1"	25.4x1.2	55			
1.5"	38.1x1.2	70			
2"	50.8x1.2	82			
2.5"	63.5x1.6	105			
3"	76.2x1.6	110			
4"	101.6x2.0	150			



- ◆ Stainless Steel Sanitary Pipe Fitting
- ◆ Valve、Pump、Fluid Facility
- ◆ 不锈钢卫生级管件、阀门、泵、流体设备

焊式异径三通 Reducing Tee

SMS | SW08

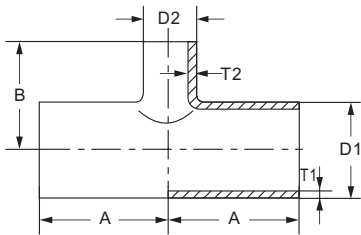

Size	D ₁ xT ₁	D ₂ xT ₂	A	B
2"x1.5"	50.8x1.2	38.1x1.2	82	70
2.5"x1.5"	63.5x1.6	38.1x1.2	105	70
2.5"x2"	63.5x1.6	50.8x1.2	105	82
3"x1.5"	76.2x1.6	38.1x1.2	110	80
3"x2.0"	76.2x1.6	50.8x1.2	110	82

焊式异径短三通 Reducing Tee Short

SMS | SW09

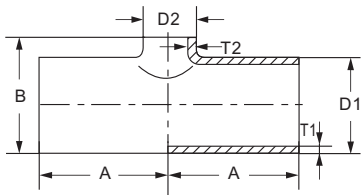

Size	D ₁ xT ₁	D ₂ xT ₂	A	B
1.5"x1"	38.1x1.2	25.4x1.2	70	40.7
2"x1"	50.8x1.2	25.4x1.2	82	54.1
2"x1.5"	50.8x1.2	38.1x1.2	82	54.1
2.5"x1.5"	63.5x1.6	38.1x1.2	105	67.5
2.5"x2"	63.5x1.6	50.8x1.2	105	66.5
3"x1.5"	76.2x1.6	38.1x1.2	110	80.6
3"x2"	76.2x1.6	50.8x1.2	110	80.6
3"x2.5"	76.2x1.6	63.5x1.6	110	80.0
4"x2"	101.6x2.0	50.8x1.2	150	106.6
4"x2.5"	101.6x2.0	63.5x1.6	150	106.6
4"x3"	101.6x2.0	76.2x1.6	150	106.6

焊式同心变径 Reducer(Concentric) / 焊式偏心变径 Reducer(Eccentric)

SMS | SW10 / SW11

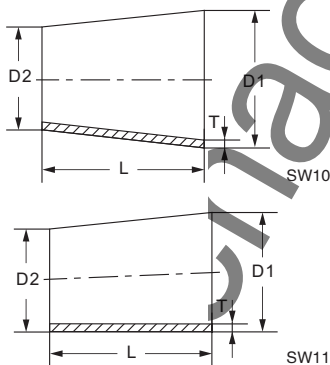

Size	D ₁ xT ₁	D ₂ xT ₂	L(同心)	L(偏心)
1.5"x1"	38.1x1.2	25.4x1.2	44	44
2"x1.5"	50.8x1.2	38.1x1.2	42	42
2"x1"	50.8x1.2	25.4x1.2	86	86
2.5"x2"	63.5x1.6	50.8x1.6	40	40
2.5"x1.5"	63.5x1.6	38.1x1.6	82	82
3"x2.5"	76.2x1.6	63.5x1.6	39	39
3"x2"	76.2x1.6	50.8x1.6	79	79
4"x3"	101.6x2.0	76.2x2.0	81	81



- ◆ Stainless Steel Sanitary Pipe Fitting
- ◆ Valve、Pump、Fluid Facility
- ◆ 不锈钢卫生级管件、阀门、泵、流体设备

卫生直管 Sanitary Pipe

BS | BW01

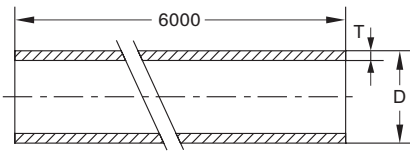

Size	DxT	A	B		
1"	25.4x1.6				
1.5"	38.1x1.6				
2"	50.8x1.6				
2.5"	63.5x1.6				
3"	76.2x1.6				
4"	101.6x2.0				

焊式加长弯头(90°) Elbow Long

BS | BW02

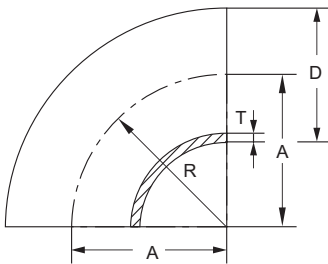

Size	DxT	A	R		
1"	25.4x1.6	38.1	38.1		
1.5"	38.1x1.6	57.2	57.2		
2"	50.8x1.6	76.2	76.2		
2.5"	63.5x1.6	95.3	95.3		
3"	76.2x1.6	114.3	114.3		
4"	101.6x2.0	152.4	152.4		

加直端焊接式弯头(90°) Elbow Long

BS | BW03

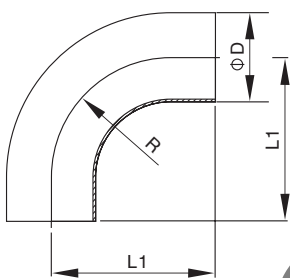

Size	DxT	L1	R		
1"	25.4x1.6	65	38.1		
1.5"	38.1x1.6	85	57.2		
2"	50.8x1.6	110	76.2		
2.5"	63.5x1.6	135	95.3		
3"	76.2x1.6	155	114.3		
4"	101.6x2.0	195	152.4		

短型焊接式弯头(45°) Short welded Elbow

BS | BW04

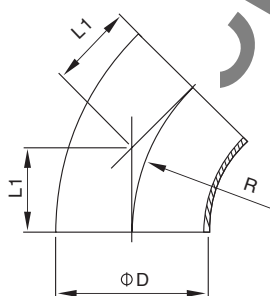

Size	DxT	L1	R		
1"	25.4x1.6	15.8	38.1		
1.5"	38.1x1.6	23.7	57.2		
2"	50.8x1.6	31.8	76.2		
2.5"	63.5x1.6	39.6	95.3		
3"	76.2x1.6	47.5	114.3		
4"	101.6x2.0	63.2	152.4		



- ◆ Stainless Steel Sanitary Pipe Fitting
- ◆ Valve、Pump、Fluid Facility
- ◆ 不锈钢卫生级管件、阀门、泵、流体设备

焊式加长弯头(45°) Elbow Long

BS | BW05

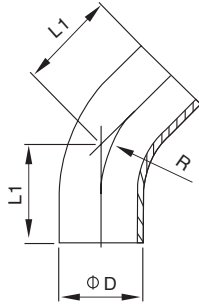

Size	DxT	L1	R
1"	25.4x1.6	30.2	38.1
1.5"	38.1x1.6	41.3	57.2
2"	50.8x1.6	58.7	76.2
2.5"	63.5x1.6	76.2	95.3
3"	76.2x1.6	93.7	114.3
4"	101.6x2.0	122.2	152.4

等径三通 Tee

BS | BW06

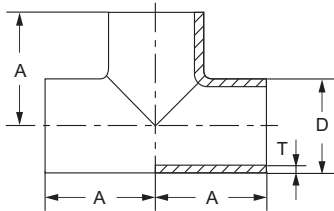

Size	DxT	A	B
1"	25.4x1.6	44	
1.5"	38.1x1.6	64	
2"	50.8x1.6	89	
2.5"	63.5x1.6	114	
3"	76.2x1.6	134	
4"	101.6x2.0	195	

等径短三通 Tee Short

BS | BW07

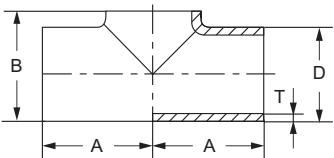

Size	DxT	A	B
1"	25.4x1.6	44	27
1.5"	38.1x1.6	64	40.6
2"	50.8x1.6	89	54.3
2.5"	63.5x1.6	114	67
3"	76.2x1.6	134	81.2
4"	101.6x2.0	195	107

焊式异径三通 Reducing Tee

BS | BW08

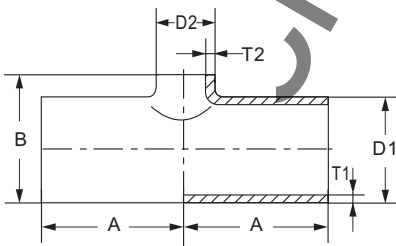

Size	D ₁ xT ₁	D ₂ xT ₂	A	B
1.5"x1"	38.1x1.6	25.4x1.6	75	40.6
2"x1.5"	50.8x1.6	38.1x1.6	89	54.3
2"x1"	50.8x1.6	25.4x1.6	89	54.3
2.5"x2"	63.5x1.6	50.8x1.6	95	67
2.5"x1.5"	63.5x1.6	38.1x1.6	95	67
2.5"x1"	63.5x1.6	25.4x1.6	95	67
3"x2.5"	76.2x1.6	63.5x1.6	95	81.2
3"x2"	76.2x1.6	50.8x1.6	95	81.2
3"x1.5"	76.2x1.6	38.1x1.6	95	81.2
4"x3"	101.6x2.0	76.2x1.6	127	107
4"x2.5"	101.6x2.0	63.5x1.6	127	107
4"x2"	101.6x2.0	50.8x1.6	127	107



- ◆ Stainless Steel Sanitary Pipe Fitting
- ◆ Valve、Pump、Fluid Facility
- ◆ 不锈钢卫生级管件、阀门、泵、流体设备

等径四通 Cross

BS | BW09

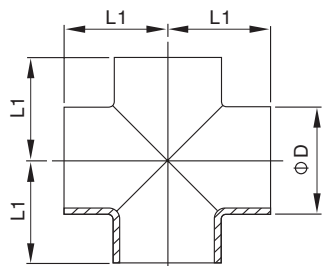

Size	DxT	L1	B
1"	25.4x1.6	65	
1.5"	38.1x1.6	85	
2"	50.8x1.6	110	
2.5"	63.5x1.6	135	
3"	76.2x1.6	155	
4"	101.6x2.0	195	

焊式同心变径管 Reducer Concentric

BS | BW10

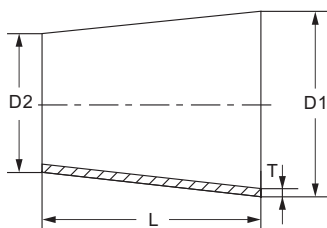

Size	D1xT1	D2xT2	L
1.5"x1"	38.1x1.6	25.4x1.6	28
2"x1.5"	50.8x1.6	38.1x1.6	31
2"x1"	50.8x1.6	25.4x1.6	49
2.5"x2"	63.5x1.6	50.8x1.6	41
2.5"x1.5"	63.5x1.6	38.1x1.6	48
2.5"x1"	63.5x1.6	25.4x1.6	76
3"x2.5"	76.2x1.6	63.5x1.6	40
3"x2"	76.2x1.6	50.8x1.6	50
3"x1.5"	76.2x1.6	38.1x1.6	74
4"x3"	101.6x2.0	76.2x1.6	51
4"x2.5"	101.6x2.0	63.5x1.6	75
4"x2"	101.6x2.0	50.8x1.6	100

焊式偏心变径管 Reducer Eccentric

BS | BW11

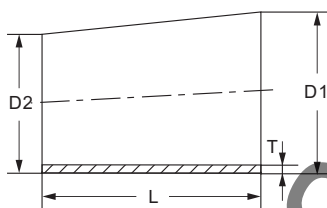

Size	D1xT1	D2xT2	L
1.5"x1"	38.1x1.6	25.4x1.6	29
2"x1.5"	50.8x1.6	38.1x1.6	39
2"x1"	50.8x1.6	25.4x1.6	48
2.5"x2"	63.5x1.6	50.8x1.6	44
2.5"x1.5"	63.5x1.6	38.1x1.6	47
2.5"x1"	63.5x1.6	25.4x1.6	73
3"x2.5"	76.2x1.6	63.5x1.6	36
3"x2"	76.2x1.6	50.8x1.6	46
3"x1.5"	76.2x1.6	38.1x1.6	70
4"x3"	101.6x2.0	76.2x1.6	78
4"x2.5"	101.6x2.0	63.5x1.6	69
4"x2"	101.6x2.0	50.8x1.6	91



- ◆ Stainless Steel Sanitary Pipe Fitting
- ◆ Valve、Pump、Fluid Facility
- ◆ 不锈钢卫生级管件、阀门、泵、流体设备

SANITARY PIPE FITTINGS 卫生级管件

卫生直管 Sanitary Pipe

3A | 3AW01

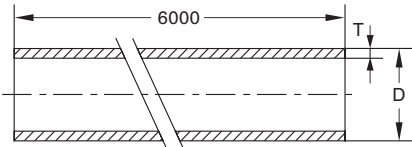

Size(inch)	T(mm)	A	B	C
1/2	1.65			
3/4	1.65			
1	1.65			
1 1/2	1.65			
2	1.65			
2 1/2	1.65			
3	1.65			
4	2.11			
6	2.8			

焊式弯头(90°) Elbow

3A | B2WC

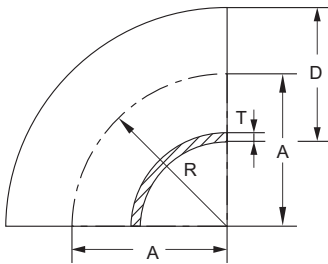

Size(inch)	T(mm)	A(inch)	R(inch)	C
1/2	1.65	3/4	3/4	
3/4	1.65	1 1/8	1 1/8	
1	1.65	1 1/2	1 1/2	
1 1/2	1.65	2 1/4	2 1/4	
2	1.65	3	3	
2 1/2	1.65	3 3/4	3 3/4	
3	1.65	4 1/2	4 1/2	
4	2.11	6	6	
6	2.8	9	9	

焊式弯头(45°) Elbow

3A | B2WK

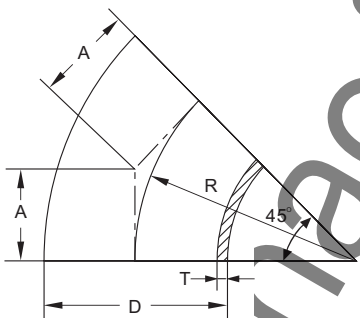

Size(inch)	T(mm)	A(inch)	R(inch)	C
1/2	1.65	9/32	3/4	
3/4	1.65	15/32	1 1/8	
1	1.65	5/8	1 1/2	
1 1/2	1.65	15/16	2 1/4	
2	1.65	1 1/4	3	
2 1/2	1.65	1 9/16	3 3/4	
3	1.65	1 7/8	4 1/2	
4	2.11	2 1/2	6	
6	2.8	3 3/4	9	



- ◆ Stainless Steel Sanitary Pipe Fitting
- ◆ Valve、Pump、Fluid Facility
- ◆ 不锈钢卫生级管件、阀门、泵、流体设备

三通 Tee

3A | B7W

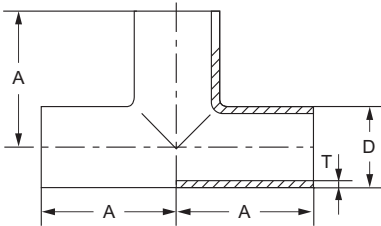

Size(inch)	T(mm)	A(inch)	R	C
1/2	1.65	3/4		
3/4	1.65	1 7/8		
1	1.65	1 7/8		
1 1/2	1.65	2 1/4		
2	1.65	3		
2 1/2	1.65	3		
3	1.65	3 1/4		
4	2.11	3 7/8		
6	2.18	5		

焊接R三通 R-Tee

3A | B29WA

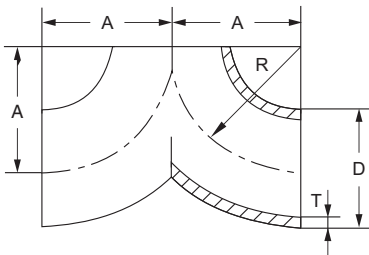

Size(inch)	T(mm)	A(inch)	R(inch)	C
1/2	1.65	3/4	3/4	
3/4	1.65	1 1/8	1 1/8	
1	1.65	1 1/2	1 1/2	
1 1/2	1.65	2 1/4	2 1/4	
2	1.65	3	3	
2 1/2	1.65	3 3/4	3 3/4	
3	1.65	4 1/2	4 1/2	
4	2.11	6	6	
6	2.8	9	9	

焊式变径三通 Reducing Tee

3A | B7WR

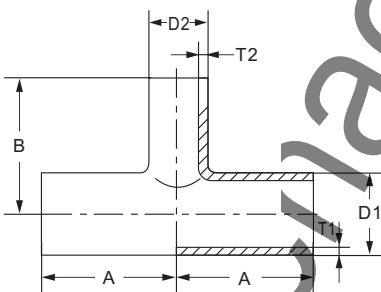

Size(inch)	T(mm)	A(inch)	B(inch)	C
3/4x1/2	1.65	1 7/8	1	
1x1/2	1.65	1 7/8	1 1/2	
1x3/4	1.65	1 7/8	2	
1 1/2x3/4	1.65	2 1/4	2 1/4	
2 1/2x1	1.65	2 1/4	2 1/8	
2x1	1.65	3	2 3/8	
2x1 1/2	1.65	3	2 1/2	
2 1/2x1 1/2	1.65	3	2 3/4	
2 1/2x2	1.65	3	3 1/4	
3x1 1/2	1.65	3 1/4	3	
3x2	1.65	3 1/4	3 1/2	
3x2 1/2	1.65	3 1/4	3 1/4	
4x2	2.11	3 7/8	4	
4x2 1/2	2.11	3 7/8	3 3/4	
4x3	2.11	3 7/8	3 3/4	
6x2	2.80	5	4 3/4	
6x3	2.80	5	4 7/8	
6x4	2.80	5	4 3/4	



- ◆ Stainless Steel Sanitary Pipe Fitting
- ◆ Valve、 Pump、 Fluid Facility
- ◆ 不锈钢卫生级管件、阀门、泵、流体设备

焊式四通 Cross

3A | B9W

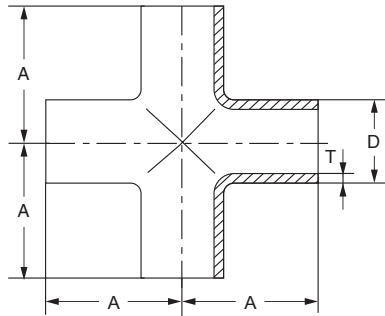

Size(inch)	T(mm)	A(inch)	B	C
1/2	1.65	3/4		
3/4	1.65	1 7/8		
1	1.65	1 7/8		
1 1/2	1.65	2 1/4		
2	1.65	3		
2 1/2	1.65	3		
3	1.65	3 1/4		
4	2.11	3 7/8		
6	2.8	5		

焊式同心变径 Reducer Concentric

3A | B31W

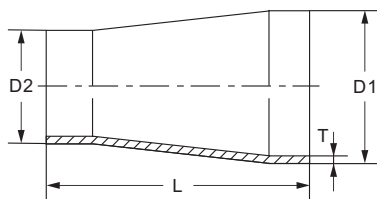

Size(inch)	T(mm)	L(inch)	R	C
1x3/4	1.65	2 3/8		
1 1/2x3/4	1.65	2 3/8		
2 1/2x1	1.65	2 3/8		
2x1	1.65	2 3/8		
2x1 1/2	1.65	2 3/8		
2 1/2x1 1/2	1.65	2 3/8		
2 1/2x2	1.65	2 3/8		
3x1 1/2	1.65	3 5/8		
3x2	1.65	3 5/8		
3x2 1/2	1.65	3 5/8		
4x2	2.11	3 5/8		
4x2 1/2	2.11	3 5/8		
4x3	2.11	3 5/8		
6x3	2.8	9		
6x4	2.8	9		

焊式偏心变径 Eccentric Reducer

3A | B32W

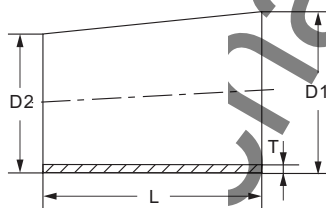

Size(inch)	T(mm)	L(inch)	C
1x3/4	1.65	1	
1 1/2x3/4	1.65	3	
2 1/2x1	1.65	2	
2x1	1.65	4	
2x1 1/2	1.65	2	
2 1/2x1 1/2	1.65	4	
2 1/2x2	1.65	2	
3x1 1/2	1.65	6	
3x2	1.65	4	
3x2 1/2	1.65	2	
4x2	2.11	8	
4x2 1/2	2.11	6	
4x3	2.11	4	
6x3	2.8	9	
6x4	2.8	9	

SANITARY PIPE FITTINGS 卫生级管件



- ◆ Stainless Steel Sanitary Pipe Fitting
- ◆ Valve、Pump、Fluid Facility
- ◆ 不锈钢卫生级管件、阀门、泵、流体设备

管帽 Cap

3A | B16W

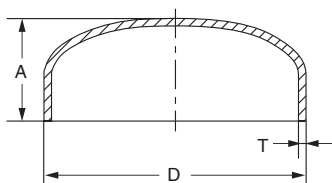

Size(inch)	T(mm)	A(inch)	B	C
1/2	1.65	1/4		
3/4	1.65	5/16		
1	1.65	3/8		
1 1/2	1.65	9/16		
2	1.65	3/4		
2 1/2	1.65	1		
3	1.65	1 1/4		
4	2.11	1 1/2		
6	2.8	2 1/4		

斜三通(45°) Lateral

3A | B28WA

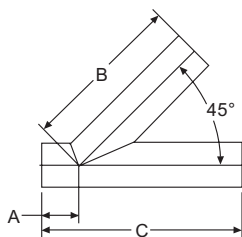

Size(inch)	A(inch)	B(inch)	C(inch)
1/2	1	5	6
3/4	1	5	6
1	1	5	6
1 1/2	1 3/16	6 3/16	7 3/8
2	1 5/8	7 1/8	8 3/4
2 1/2	1 1/2	8 1/2	10
3	1 7/8	8 7/8	10 3/4
4	2 1/16	10 3/4	12 13/16

对焊Y三通(45°) Y-Branch

3A | 28AMP

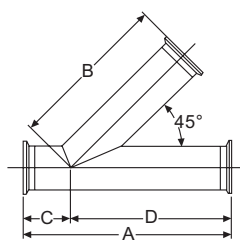

Size(inch)	T(mm)	A(inch)	B(inch)	C(inch)	D(inch)
1	1.65	7	5 1/2	1 1/2	5 1/2
1 1/2	1.65	8 3/8	6 11/16	1 11/16	6 11/16
2	1.65	9 3/4	7 5/8	2 1/8	7 5/8
2 1/2	1.65	11	9	2	9
3	1.65	11 3/4	9 3/8	2 3/8	9 3/8
4	2.11	14	11 5/16	2 11/16	11 5/16



- ◆ Stainless Steel Sanitary Pipe Fitting
- ◆ Valve、 Pump、 Fluid Facility
- ◆ 不锈钢卫生级管件、阀门、泵、流体设备

SANITARY PIPE FITTINGS 卫生级管件

焊式加长弯头(90°) Elbow Long

3A | 2CW

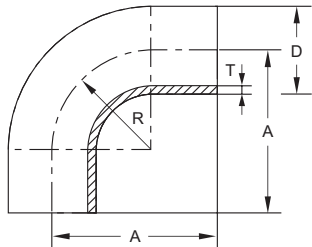

Size(inch)	T(mm)	A(inch)	R(inch)	C
1	1.65	2 1/16	1 1/2	
1 1/2	1.65	2 15/16	2 1/4	
2	1.65	4 1/16	3	
2 1/2	1.65	5 3/16	3 3/4	
3	1.65	6 5/16	4 1/2	
4	2.11	8 5/16	6	

一卡式加长弯头(90°) Elbow both ends Ferrule/Weld

3A | 2CKW

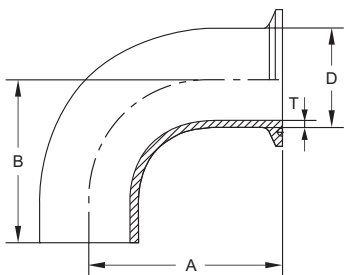

Size(inch)	T(mm)	A(inch)	B(inch)	C
1	1.65	2 9/16	2 1/16	
1 1/2	1.65	3 7/16	2 15/16	
2	1.65	4 9/16	4 1/16	
2 1/2	1.65	5 11/16	5 3/16	
3	1.65	6 13/16	6 5/16	
4	2.11	8 15/16	8 5/16	

焊式加长弯头(45°) Elbow Long

3A | 2KW

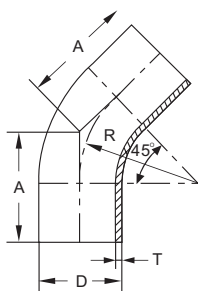

Size(inch)	T(mm)	A(inch)	R(inch)	C
1	1.65	1 3/16	1 1/2	
1 1/2	1.65	1 5/8	2 1/4	
2	1.65	2 5/16	3	
2 1/2	1.65	3	3 3/4	
3	1.65	3 11/16	4 1/2	
4	2.11	4 13/16	6	

一卡式加长弯头(45°) Elbow both ends Ferrule/Weld

3A | 2CKW

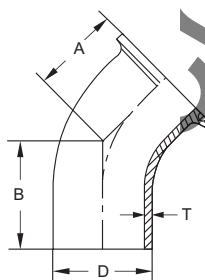

Size(inch)	T(mm)	A(inch)	B(inch)	C
1	1.65	1 11/16	1 3/16	
1 1/2	1.65	2 1/8	1 5/8	
2	1.65	2 13/16	2 5/16	
2 1/2	1.65	3 1/2	3	
3	1.65	4 3/16	3 11/16	
4	2.11	5 7/16	4 13/16	



- ◆ Stainless Steel Sanitary Pipe Fitting
- ◆ Valve、Pump、Fluid Facility
- ◆ 不锈钢卫生级管件、阀门、泵、流体设备

焊式三通 Tee

3A | 7W

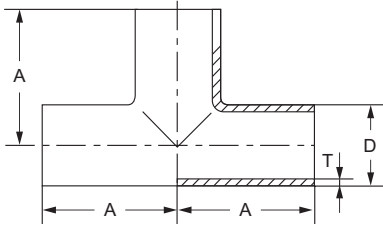

Size(inch)	T(mm)	A(inch)	B	C
1	1.65	1 1/8		
1 1/2	1.65	1 21/32		
2	1.65	2 1/16		
2 1/2	1.65	2 11/32		
3	1.65	2 19/32		
4	2.11	3 7/16		

焊式变径三通 Reducing Tee

3A | 7WR

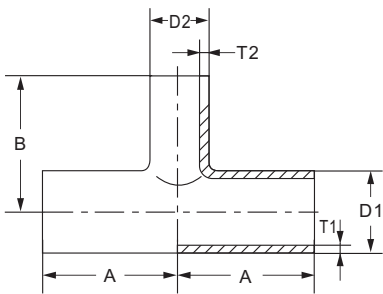

Size(inch)	T1(mm)	T2(mm)	A(inch)	B(inch)
1 1/2x1	1.65	1.65	1 31/32	1 3/8
2x1	1.65	1.65	2 1/16	1 5/8
2x1 1/2	1.65	1.65	2 1/16	1 29/32
2 1/2x1	1.65	1.65	2 11/32	1 7/8
2 1/2x1 1/2	1.65	1.65	2 11/32	2 5/32
2 1/2x2	1.65	1.65	2 11/32	2 5/16
3x1	1.65	1.65	2 19/31	2 1/8
3x1 1/2	1.65	1.65	2 19/31	2 13/32
3x2	1.65	1.65	2 19/31	2 9/16
3x2 1/2	1.65	1.65	2 19/31	2 19/32
4x1	2.11	1.65	3 7/16	2 5/8
4x1 1/2	2.11	1.65	3 7/16	2 29/32
4x2	2.11	1.65	3 7/16	3 1/16
4x2 1/2	2.11	1.65	3 7/16	3 3/32
4x3	2.11	1.65	3 7/16	3 3/32
6x3	2.80	1.65	5	4 3/4
6x4	2.80	2.11	5	4 7/8

卡式四通 Cross

3A | 9W

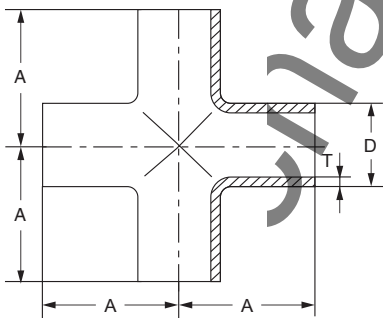

Size(inch)	T(mm)	A(inch)	B	C
1	1.65	1 1/8		
1 1/2	1.65	1 21/32		
2	1.65	2 1/16		
2 1/2	1.65	2 11/32		
3	1.65	2 19/32		
4	2.11	3 7/16		



- ◆ Stainless Steel Sanitary Pipe Fitting
- ◆ Valve、Pump、Fluid Facility
- ◆ 不锈钢卫生级管件、阀门、泵、流体设备

焊式同心变径 Concentric Reducer

3A | 31W

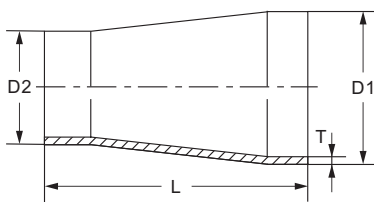

Size(inch)	T(mm)	L(inch)	B	C
1 1/4x3/4	1.65	2 3/8		
1 1/4x1	1.65	2 3/8		
1 1/2x1 1/4	1.65	2 3/8		
1 1/2x1	1.65	2 3/8		
2x1/2	1.65	4 3/8		
2x3/4	1.65	4		
2x1	1.65	2 3/8		
2x1 1/4	1.65	2 3/8		
2x1 1/2	1.65	2 3/8		
2 1/2x1	1.65	2 3/8		
2 1/2x1 1/4	1.65	4		
2 1/2x1 1/2	1.65	2 3/8		
2 1/2x2	1.65	2 3/8		
3x1	1.65	5 1/4		
3x1 1/2	1.65	3 5/8		
3x2	1.65	3 5/8		
3x2 1/2	1.65	3 5/8		
4x1 1/2	2.11	5 1/4		
4x2	2.11	3 5/8		
4x2 1/2	2.11	3 5/8		
4x3	2.11	3 5/8		
6x3	2.8	9		
6x4	2.8	9		

焊式同心变径 Concentric Reducer

3A | 31WC

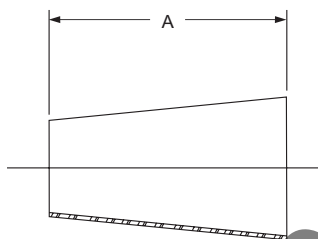

Size(inch)	T(mm)	A(inch)	B	C
1 1/2x1	1.65	2		
2x1	1.65	4		
2x1 1/2	1.65	2		
2 1/2x1	1.65	6		
2 1/2x1 1/2	1.65	4		
2 1/2x2	1.65	2		
3x1	1.65	8		
3x1 1/2	1.65	6		
3x2	1.65	4		
3x2 1/2	1.65	2		
4x1	2.11	12		
4x1 1/2	2.11	10		
4x2	2.11	8		
4x2 1/2	2.11	6		
4x3	2.11	4		
6x3	2.8	6		
6x4	2.8	4		

SANITARY PIPE FITTINGS 卫生级管件



- ◆ Stainless Steel Sanitary Pipe Fitting
- ◆ Valve、Pump、Fluid Facility
- ◆ 不锈钢卫生级管件、阀门、泵、流体设备

焊式偏心变径 Eccentric Reducer

3A | 32W

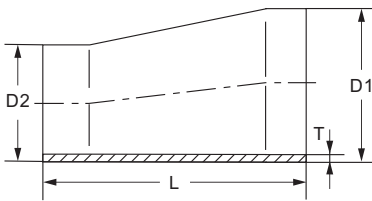

Size(inch)	T(mm)	A(inch)	B	C
1 1/2x1	1.65	2		
2x1	1.65	4		
2x1 1/2	1.65	2		
2 1/2x1	1.65	6		
2 1/2x1 1/2	1.65	4		
2 1/2x2	1.65	2		
3x1	1.65	8		
3x1 1/2	1.65	6		
3x2	1.65	4		
3x2 1/2	1.65	2		
4x1	2.11	12		
4x1 1/2	2.11	10		
4x2	2.11	8		
4x2 1/2	2.11	6		
4x3	2.11	4		
6x3	2.8	9		
6x4	2.8	9		

Y三通 True Wye

3A | 28BWWW

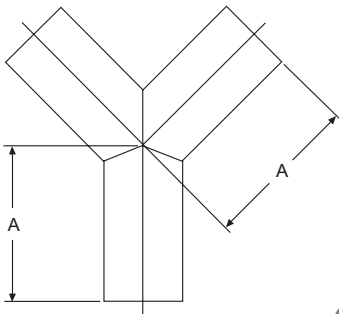

Size(inch)	T(mm)	A(inch)	B	C
1	1.65	3		
1 1/2	1.65	3		
2	1.65	4		
2 1/2	1.65	5		
3	1.65	6		
4	2.11	8		
6	2.11	8		

对焊Y三通(45°) Lateral

3A | 28AWWW

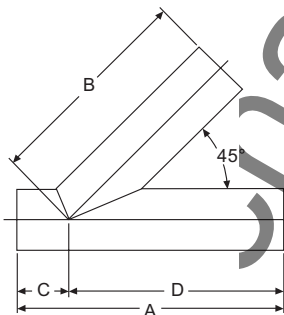

Size(inch)	T(mm)	A(inch)	B(inch)	C(inch)	D(inch)
1	1.65	3 5/8	3 13/16	1/2	3 1/8
1 1/2	1.65	4 3/8	4 9/16	7/8	3 1/2
2	1.65	5 1/8	5	1 1/8	4
2 1/2	1.65	6 5/8	6 3/8	1 5/8	5
3	1.65	8 1/2	7 3/4	2	6 1/2
4	2.11	10 1/2	9 3/8	2 3/8	8 1/8



- ◆ Stainless Steel Sanitary Pipe Fitting
- ◆ Valve、Pump、Fluid Facility
- ◆ 不锈钢卫生级管件、阀门、泵、流体设备

卡式弯头(90°) Elbow Both ends Ferrule

3A | 2CMP

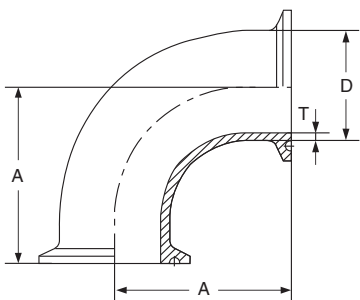

Size(inch)	T(mm)	A(inch)	B	C
1/2	1.65	1 1/4		
3/4	1.65	1 5/8		
1	1.65	2		
1 1/2	1.65	2 3/4		
2	1.65	3 1/2		
2 1/2	1.65	4 1/4		
3	1.65	5		
4	2.11	6 5/8		
6	2.8	10 1/2		

卡式弯头(45°) Elbow

3A | 2CMP

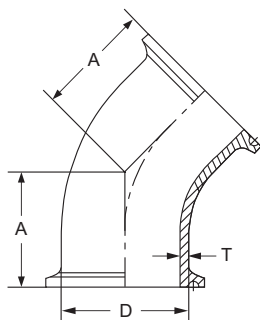

Size(inch)	T(mm)	A(inch)	B	C
1/2	1.65	25/32		
3/4	1.65	31/32		
1	1.65	1 1/8		
1 1/2	1.65	1 7/16		
2	1.65	1 3/4		
2 1/2	1.65	2 1/16		
3	1.65	2 3/8		
4	2.11	3 1/8		
6	2.8	5 1/4		

卡式等径三通 Tee

3A | 7MP

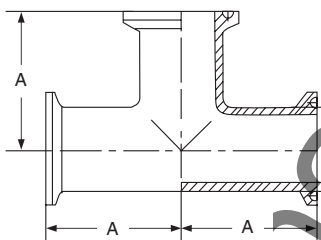

Size(inch)	T(mm)	A(inch)	B	C
1/2	1.65	1 1/4		
3/4	1.65	2 3/8		
1	1.65	2 3/8		
1 1/2	1.65	2 3/4		
2	1.65	3 1/2		
2 1/2	1.65	3 1/2		
3	1.65	3 3/4		
4	2.11	4 1/2		
6	2.8	6 1/2		



- ◆ Stainless Steel Sanitary Pipe Fitting
- ◆ Valve、Pump、Fluid Facility
- ◆ 不锈钢卫生级管件、阀门、泵、流体设备

卡式四通 Cross

3A | 9MP

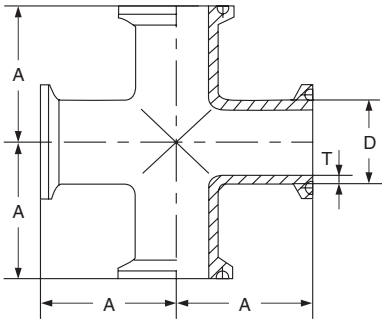

Size(inch)	T(mm)	A(inch)	B	C
1/2	1.65	1 1/4		
3/4	1.65	2 3/8		
1	1.65	2 3/8		
1 1/2	1.65	2 3/4		
2	1.65	3 1/2		
2 1/2	1.65	3 1/2		
3	1.65	3 3/4		
4	2.11	4 1/2		
6	2.8	6 1/2		

卡式变径三通 Reducing Tee ends Ferrule

3A | 7RMP

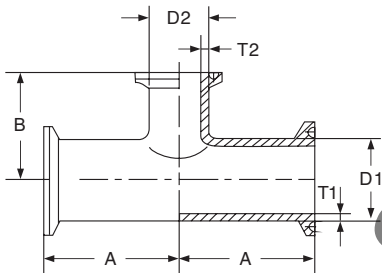

Size(inch)	T1(mm)	T2(mm)	A(inch)	B(inch)	C
3/4x1/2	1.65	1.65	2 5/8	2 5/8	
1x1/2	1.65	1.65	2 5/8	2 5/8	
1x3/4	1.65	1.65	2 5/8	2 5/8	
1 1/2x1/2	1.65	1.65	2 7/8	2 7/8	
1 1/2x3/4	1.65	1.65	2 7/8	2 7/8	
1 1/2x1	1.65	1.65	2 5/32	1 7/8	
2x1/2	1.65	1.65	2 9/16	2 1/8	
2x3/4	1.65	1.65	2 9/16	2 1/8	
2x1	1.65	1.65	2 9/16	2 1/8	
2x1 1/2	1.65	1.65	2 9/16	2 13/32	
2 1/2x1/2	1.65	1.65	2 27/32	2 3/8	
2 1/2x3/4	1.65	1.65	2 27/32	2 3/8	
2 1/2x1	1.65	1.65	2 27/32	2 3/8	
2 1/2x1 1/2	1.65	1.65	2 27/32	2 21/32	
2 1/2x2	1.65	1.65	2 27/32	2 13/16	
3x3/4	1.65	1.65	3 3/32	2 5/8	
3x1	1.65	1.65	3 3/32	2 5/8	
3x1 1/2	1.65	1.65	3 3/32	2 29/32	
3x2	1.65	1.65	3 3/32	3 1/16	
3x2 1/2	1.65	1.65	3 3/32	3 3/32	
4x1	2.11	1.65	4 1/16	3 1/8	
4x1 1/2	2.11	1.65	4 1/16	3 13/32	
4x2	2.11	1.65	4 1/16	3 19/32	
4x2 1/2	2.11	1.65	4 1/16	3 19/32	
4x3	2.11	1.65	4 1/16	3 19/32	
6x3	2.80	1.65	5 7/8	5 1/4	
6x4	2.80	2.11	5 7/8	5 1/2	



- ◆ Stainless Steel Sanitary Pipe Fitting
- ◆ Valve、Pump、Fluid Facility
- ◆ 不锈钢卫生级管件、阀门、泵、流体设备

卡式同心变径 Concentric Reducer

3A | 31-14MP

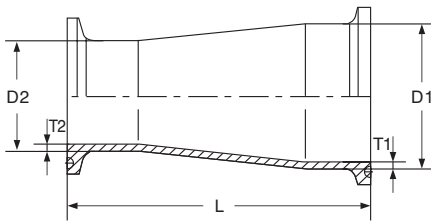

Size(inch)	T1(mm)	T2(mm)	A(inch)	B	C
3/4x1/2	1.65	1.65	2		
1x1/2	1.65	1.65	3 3/8		
1x3/4	1.65	1.65	3 3/8		
1 1/2x1/2	1.65	1.65	3 3/8		
1 1/2x3/4	1.65	1.65	3 3/8		
1 1/2x1	1.65	1.65	3 3/8		
2x1	1.65	1.65	3 3/8		
2x1 1/2	1.65	1.65	3 3/8		
2 1/2x1/2	1.65	1.65	3 3/8		
2 1/2x2	1.65	1.65	3 3/8		
3x1 1/2	1.65	1.65	4 5/8		
3x2	1.65	1.65	4 5/8		
3x2 1/2	1.65	1.65	4 5/8		
4x2	2.11	1.65	4 5/8		
4x2 1/2	2.11	1.65	4 5/8		
4x3	2.11	1.65	4 5/8		
6x3	2.80	1.65	10 3/8		
6x4	2.80	2.11	10 1/2		

卡式偏心变径 Eccentric Reducer

3A | 32-14MP

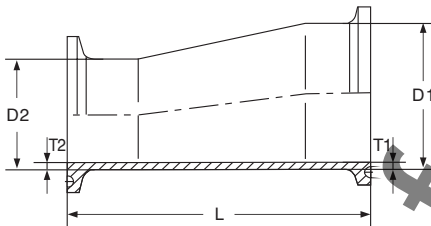

Size(inch)	T1(mm)	T2(mm)	A(inch)	B	C
3/4x1/2	1.65	1.65	2		
1x1/2	1.65	1.65	3		
1x 3/4	1.65	1.65	2		
1 1/2x1/2	1.65	1.65	5		
1 1/2x3/4	1.65	1.65	4		
1 1/2x1	1.65	1.65	3		
2x1	1.65	1.65	5		
2x1 1/2	1.65	1.65	3		
2 1/2x1/2	1.65	1.65	5		
2 1/2x2	1.65	1.65	3		
3x1 1/2	1.65	1.65	7		
3x2	1.65	1.65	5		
3x2 1/2	1.65	1.65	3		
4x2	2.11	1.65	9 1/8		
4x2 1/2	2.11	1.65	7 1/8		
4x3	2.11	1.65	5 1/8		
6x3	2.80	1.65	10 3/8		
6x4	2.80	2.11	10 1/2		

Y三通 True Y

3A | 28BMP

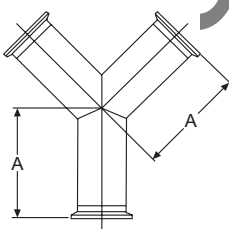

Size(inch)	T(mm)	A(inch)	B	C
1/2	1.65	2 1/2		
3/4	1.65	2 1/2		
1	1.65	3 1/2		
1 1/2	1.65	3 1/2		
2	1.65	4 1/2		
2 1/2	1.65	5 1/2		
3	1.65	6 1/2		
4	2.11	8 5/8		
6	2.8	8 3/4		



- ◆ Stainless Steel Sanitary Pipe Fitting
- ◆ Valve、Pump、Fluid Facility
- ◆ 不锈钢卫生级管件、阀门、泵、流体设备

ASME BPE Standard Specification

Design Requirement: Automatic Welding, Ovality, Wall Thickness and Squareness

Traceability (Laser Marking): Heat Number, Size, Grade, Surface Finishes and Material

Packing: Color Coded End Caps, Transparent Plastic Bag, and Detailed Label

Tolerance:

Nominal OD Size	1/2"	3/4"	1"	1 1/2"	2"	2 1/2"	3"	4"	6"
O.D. Tolerance	±.005	±.005	±.005	±.008	±.008	±.010	±.010	±.015	±.030
Nominal Wall Thickness	.065	.065	.065	.065	.065	.065	.065	.083	.109
Wall Thickness Tolerance before EP	+.005 - .008	+.005 - .008	+.005 - .008	+.005 - .008	+.005 - .008	+.005 - .008	+.005 - .008	+.008 - .010	+.015 - .015
Wall Thickness Tolerance after EP	+.005 - .010	+.005 - .010	+.005 - .010	+.005 - .010	+.005 - .010	+.005 - .010	+.005 - .010	+.008 - .012	+.015 - .017
Control Length (C)	.750	.750	.750	.750	.750	.750	.750	.750	.750
Tangent Length (T)	1.500	1.500	1.500	1.500	1.500	1.500	1.750	2.000	2.500
Squareness Face to Tangent (B)	.005	.005	.008	.008	.008	.010	.016	.016	.030
Off Angle (O)	.014	.018	.025	.034	.043	.054	.068	.086	.135
Off Plane (P)	±.030	±.030	±.030	±.050	±.050	±.050	±.050	±.060	±.060

•Roundness



•Wall Thickness



•Squareness Face to Tangent



•Off Angle



•Off Plane



•Height

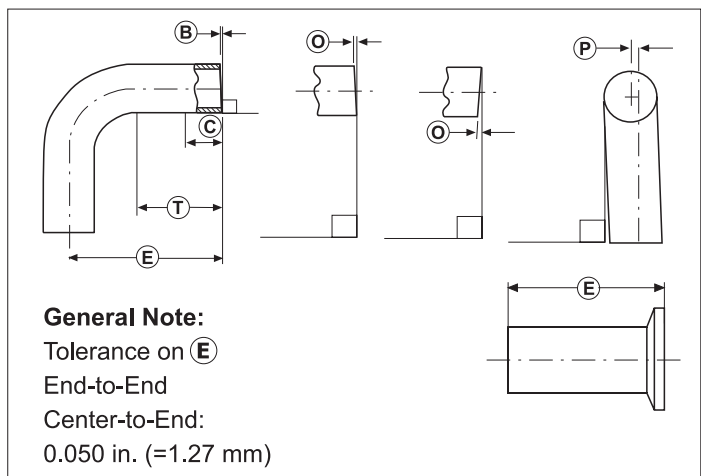
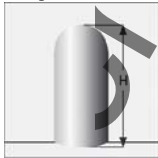



- ◆ Stainless Steel Sanitary Pipe Fitting
- ◆ Valve、Pump、Fluid Facility
- ◆ 不锈钢卫生级管件、阀门、泵、流体设备

Surface Treatment: Acceptance Criteria for ID Surface Finishes

ANOMALY OR INDICATION	ACCEPTANCE CRITERIA
Cluster of pits	None accepted.
Discoloration(Demarcation)	If < 5% of the total area when visually inspected and Ra is met.
Grit lines	If Ra is met.
Longitudinal welds	If polished smooth, blended, and Ra is met.
Nicks	None accepted.
Oxides	None accepted.
Pits	If dia. < 0.020", and bottom is shiny.
Scratches	If length < 0.25", depth < 0.003", and Ra is met.
Star burst	None accepted.
Surface cracks	None accepted.
Surface inclusions	If Ra is met and there is no liquid penetrant indication.
Surface residuals	None accepted, visual inspection without magnification.
Surface roughness(Ra)	See Tables Surface Finishes.
Water stains	If no deposits.
Weld slag	None accepted.
Weld porosity	None accepted.

Surface Finish Code	Maximum Interior Surface Finish	Exterior Surface Finish	ASME BPE Surface Finish Designation
#3(PC)	20 Ra Mechanical	Unpolished	SFF1
#7(PL)	20 Ra Mechanical	Polished	SFF1
#3E(PD)	15 Ra Electropolish	Unpolished	SFF4
#7E(PM)	15 Ra Electropolish	Polished	SFF4
#3E(PJ)	10 Ra Electropolish	Unpolished	
#7E(PR)	10 Ra Electropolish	Polished	
#0(PU)	Unpolished	Unpolished	

CONVERSION OF SURFACE FINISHES CHART:

STANDARD GRIT	Ra		RMS	
	μ-in	μ-m	μ-in	μ-m
150grit	27-32	0.68-0.80	30-35	0.76-0.89
180grit	18-23	0.46-0.58	20-25	0.51-0.64
240grit	14-18	0.34-0.46	15-20	0.38-0.51
320grit	8-10	0.21-0.25	9-11	0.23-0.28

GENERAL NOTE: All Ra readings are taken across the lay.

NOTE: The average Ra is derived from reading taken at four cross sections approximately 90° apart, Other Ra readings are available if agreed upon between vendor and owner/user. No single reading exceeding Ra max.

Test Procedures:

- Verification of Material Grade
- Visual Inspection
- Welds
- Internal Surface Roughness Measurement
- Control of Dimensions
- Internal Surface
- End Preparation

Documentation: Certified Material Test Report 3.1B as Per DIN EN10204.



- ◆ Stainless Steel Sanitary Pipe Fitting
- ◆ Valve、Pump、Fluid Facility
- ◆ 不锈钢卫生级管件、阀门、泵、流体设备

BPE直管 BPE Pipe

| BPE | BPEW01

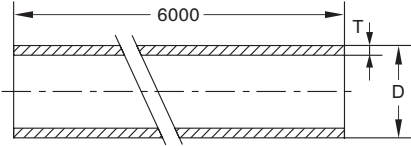

Size(inch)	T(mm)	A	B	C
1/2	1.65			
3/4	1.65			
1	1.65			
1 1/2	1.65			
2	1.65			
2 1/2	1.65			
3	1.65			
4	2.11			
6	2.8			

焊式加长弯头(90°) Elbow

| BPE | S2S

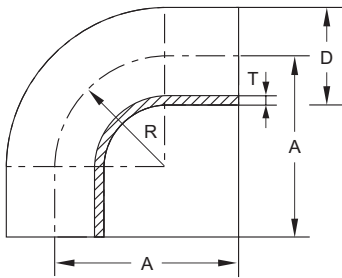

Size(inch)	T(mm)	A(inch)	R(inch)	C
1/2	1.65	3	1 1/4	
3/4	1.65	3	1 1/2	
1	1.65	3	1 1/2	
1 1/2	1.65	3 3/4	2 1/4	
2	1.65	4 3/4	3	
2 1/2	1.65	5 1/2	3 3/4	
3	1.65	6 1/4	4 1/2	
4	2.11	8	6	
6	2.8	11 1/2	9	

一卡一焊式弯头(90°) Elbow both ends Ferrule/Weld

| BPE | S2CKW

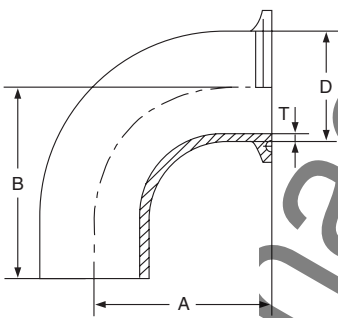

Size(inch)	T(mm)	A(inch)	B(inch)	C
1/2	1.65	1 5/8	3	
3/4	1.65	1 5/8	3	
1	1.65	2	3	
1 1/2	1.65	2 3/4	3 3/4	
2	1.65	3 1/2	4 3/4	
2 1/2	1.65	4 1/4	5 1/2	
3	1.65	5	6 1/4	
4	2.11	6 5/8	8	
6	2.8	10 1/2	11 1/2	



- ◆ Stainless Steel Sanitary Pipe Fitting
- ◆ Valve、 Pump、 Fluid Facility
- ◆ 不锈钢卫生级管件、阀门、泵、流体设备

卡式弯头(90°) Elbow

BPE | S2CMP

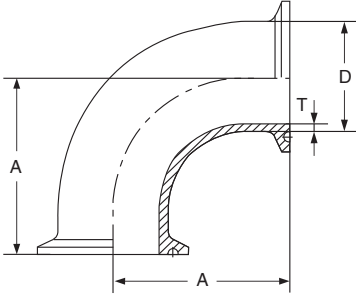

Size(inch)	T(mm)	A(inch)	B	C
1/2	1.65	1 5/8		
3/4	1.65	1 5/8		
1	1.65	2		
1 1/2	1.65	2 3/4		
2	1.65	3 1/2		
2 1/2	1.65	4 1/4		
3	1.65	5		
4	2.11	6 5/8		
6	2.8	10 1/2		

焊式加长弯头(45°) Elbow

BPE | S2KS

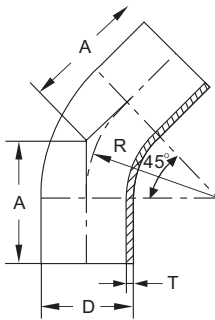

Size(inch)	T(mm)	A(inch)	R(inch)	C
1/2	1.65	2 1/4	1 1/4	
3/4	1.65	2 1/4	1 1/2	
1	1.65	2 1/4	1 1/2	
1 1/2	1.65	2 1/2	2 1/4	
2	1.65	3	3	
2 1/2	1.65	3 3/8	3 3/4	
3	1.65	3 5/8	4 1/2	
4	2.11	4 1/2	6	
6	2.8	6 1/4	9	

一卡一焊式弯头(45°) Elbow both ends Ferrule/Weld

BPE | S2KKW

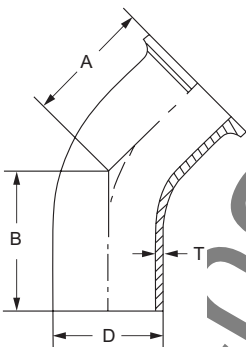

Size(inch)	T(mm)	A(inch)	B(inch)	C
1/2	1.65	1	2 1/4	
3/4	1.65	1	2 1/4	
1	1.65	1 1/8	2 1/4	
1 1/2	1.65	1 7/16	2 1/2	
2	1.65	1 3/4	3	
2 1/2	1.65	2 1/16	3 3/8	
3	1.65	2 3/8	3 5/8	
4	2.11	3 1/8	4 1/2	
6	2.8	5 1/4	6 1/4	



- ◆ Stainless Steel Sanitary Pipe Fitting
- ◆ Valve、Pump、Fluid Facility
- ◆ 不锈钢卫生级管件、阀门、泵、流体设备

卡式弯头(45°) Elbow both ends Ferrule

| BPE | S2KMP

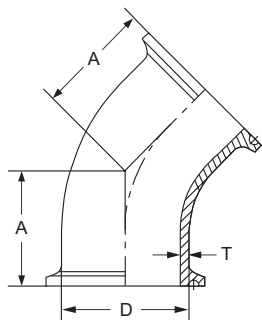

Size(inch)	T(mm)	A(inch)	B	C
1/2	1.65	1		
3/4	1.65	1		
1	1.65	1 1/8		
1 1/2	1.65	1 7/16		
2	1.65	1 3/4		
2 1/2	1.65	2 1/16		
3	1.65	2 3/8		
4	2.11	3 1/8		
6	2.8	5 1/4		

焊式三通 Tee ends Weld

| BPE | S7WWW

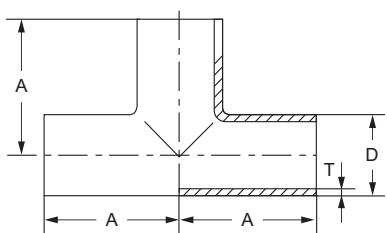

Size(inch)	T(mm)	A(inch)	B	C
1/2	1.65	1 7/8		
3/4	1.65	2		
1	1.65	2 1/8		
1 1/2	1.65	2 3/8		
2	1.65	2 7/8		
2 1/2	1.65	3 1/8		
3	1.65	3 3/8		
4	2.11	4 1/8		
6	2.8	5 5/8		

卡式三通 Tee ends Ferrule

| BPE | S7MP

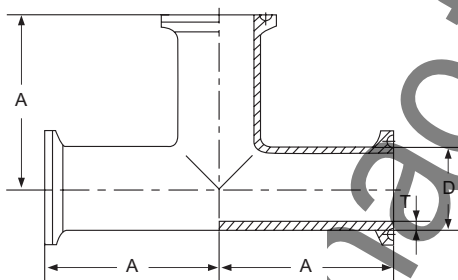

Size(inch)	T(mm)	A(inch)	B	C
1/2	1.65	2 1/4		
3/4	1.65	2 3/8		
1	1.65	2 5/8		
1 1/2	1.65	2 7/8		
2	1.65	3 3/8		
2 1/2	1.65	3 5/8		
3	1.65	3 7/8		
4	2.11	4 3/4		
6	2.8	7 1/8		



- ◆ Stainless Steel Sanitary Pipe Fitting
- ◆ Valve、Pump、Fluid Facility
- ◆ 不锈钢卫生级管件、阀门、泵、流体设备

卡式等径短三通 Short Outlet Tee

BPE | S7MPS

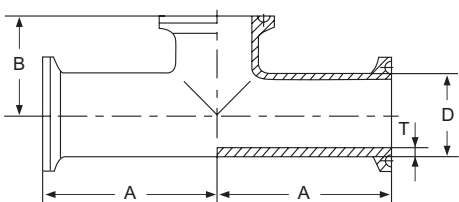

Size(inch)	T(mm)	A(inch)	B(inch)	C
1/2	1.65	2 1/4	1	
3/4	1.65	2 3/8	1 1/8	
1	1.65	2 5/8	1 1/8	
1 1/2	1.65	2 7/8	1 3/8	
2	1.65	3 3/8	1 5/8	
2 1/2	1.65	3 5/8	1 7/8	
3	1.65	3 7/8	2 1/8	
4	2.11	4 3/4	2 3/4	
6	2.8	7 1/8	4 5/8	

一卡两焊等径长三通 Tee branch Ferrule

BPE | S7WWK

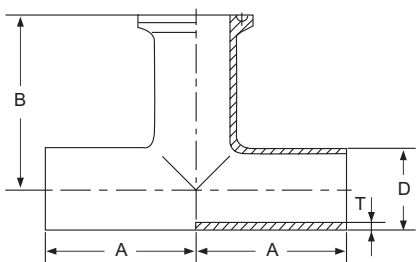

Size(inch)	T(mm)	A(inch)	B(inch)	C
1/2	1.65	1 7/8	1 1/4	
3/4	1.65	2	2 3/8	
1	1.65	2 1/8	2 5/8	
1 1/2	1.65	2 3/8	2 7/8	
2	1.65	2 7/8	3 3/8	
2 1/2	1.65	3 1/8	3 5/8	
3	1.65	3 3/8	3 7/8	
4	2.11	4 1/8	4 3/4	
6	2.8	5 5/8	7 1/8	

一卡两焊等径三通 Short Outlet Tee/Branch Ferrule

BPE | S7SWWK

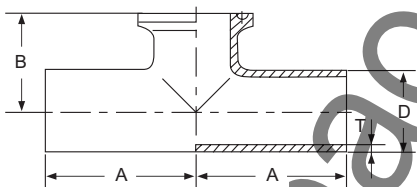

Size(inch)	T(mm)	A(inch)	B(inch)	C
1/2	1.65	1 7/8	1	
3/4	1.65	2	1 1/8	
1	1.65	2 1/8	1 1/8	
1 1/2	1.65	2 3/8	1 3/8	
2	1.65	2 7/8	1 5/8	
2 1/2	1.65	3 1/8	1 7/8	
3	1.65	3 3/8	2 1/8	
4	2.11	4 1/8	2 3/4	
6	2.8	5 5/8	4 5/8	



- ◆ Stainless Steel Sanitary Pipe Fitting
- ◆ Valve、Pump、Fluid Facility
- ◆ 不锈钢卫生级管件、阀门、泵、流体设备

焊式变径三通 Reducing Tee

| BPE | S7RWWW

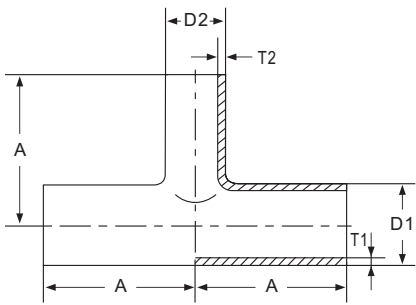

Size(inch)	T1(mm)	T2(mm)	A(inch)	B(inch)
3/4x1/2	1.65	1.65	2	2
1x1/2	1.65	1.65	2 1/8	2 1/8
1x3/4	1.65	1.65	2 1/8	2 1/8
1 1/2x1/2	1.65	1.65	2 3/8	2 3/8
1 1/2x3/4	1.65	1.65	2 3/8	2 3/8
1 1/2x1	1.65	1.65	2 3/8	2 3/8
2x1/2	1.65	1.65	2 7/8	2 5/8
2x3/4	1.65	1.65	2 7/8	2 5/8
2x1	1.65	1.65	2 7/8	2 5/8
2x1 1/2	1.65	1.65	2 7/8	2 5/8
2 1/2x1/2	1.65	1.65	3 1/8	2 7/8
2 1/2x3/4	1.65	1.65	3 1/8	2 7/8
2 1/2x1	1.65	1.65	3 1/8	2 7/8
2 1/2x1 1/2	1.65	1.65	3 1/8	2 7/8
2 1/2x2	1.65	1.65	3 1/8	2 7/8
3x1/2	1.65	1.65	3 3/8	3 1/8
3x3/4	1.65	1.65	3 3/8	3 1/8
3x1	1.65	1.65	3 3/8	3 1/8
3x1 1/2	1.65	1.65	3 3/8	3 1/8
3x2	1.65	1.65	3 3/8	3 1/8
3x2 1/2	1.65	1.65	3 3/8	3 1/8
4x1/2	2.11	1.65	4 1/8	3 1/8
4x3/4	2.11	1.65	4 1/8	3 5/8
4x1	2.11	1.65	4 1/8	3 5/8
4x1 1/2	2.11	1.65	4 1/8	3 5/8
4x2	2.11	1.65	4 1/8	3 7/8
4x2 1/2	2.11	1.65	4 1/8	3 7/8
4x3	2.11	1.65	4 1/8	3 7/8
6x4	2.80	2.11	5 5/8	5 1/8

一卡两焊等径三通 Tee ends Ferrule

| BPE | S7WKW

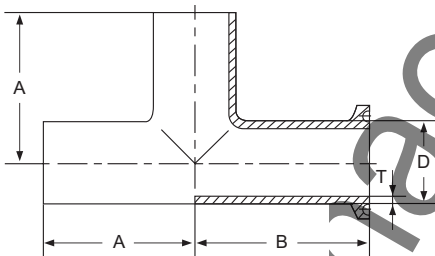

Size(inch)	T(mm)	A(inch)	B(inch)	C
1/2	1.65	1 7/8	1 1/4	
3/4	1.65	2	2 3/8	
1	1.65	2 1/8	2 5/8	
1 1/2	1.65	2 3/8	2 7/8	
2	1.65	2 7/8	3 3/8	
2 1/2	1.65	3 1/8	3 5/8	
3	1.65	3 3/8	3 7/8	
4	2.11	4 1/8	4 3/4	
6	2.8	5 5/8	7 1/8	



- ◆ Stainless Steel Sanitary Pipe Fitting
- ◆ Valve、Pump、Fluid Facility
- ◆ 不锈钢卫生级管件、阀门、泵、流体设备

一卡两焊变径三通 Reducing Tee/Branch Ferrule

BPE | S7RWWK

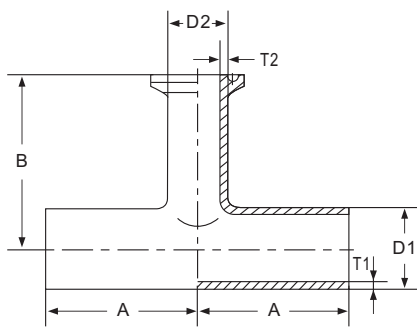

Size(inch)	T1(mm)	T2(mm)	A(inch)	B(inch)
3/4x1/2	1.65	1.65	2	2
1x1/2	1.65	1.65	2 1/8	2 5/8
1x3/4	1.65	1.65	2 1/8	2 5/8
1 1/2x1/2	1.65	1.65	2 3/8	2 7/8
1 1/2x3/4	1.65	1.65	2 3/8	2 7/8
1 1/2x1	1.65	1.65	2 3/8	2 7/8
2x1/2	1.65	1.65	2 7/8	3 1/8
2x3/4	1.65	1.65	2 7/8	3 1/8
2x1	1.65	1.65	2 7/8	3 1/8
2x1 1/2	1.65	1.65	2 7/8	3 1/8
2 1/2x1/2	1.65	1.65	3 1/8	3 3/8
2 1/2x3/4	1.65	1.65	3 1/8	3 3/8
2 1/2x1	1.65	1.65	3 1/8	3 3/8
2 1/2x1 1/2	1.65	1.65	3 1/8	3 3/8
2 1/2x2	1.65	1.65	3 1/8	3 3/8
3x1/2	1.65	1.65	3 3/8	3 5/8
3x3/4	1.65	1.65	3 3/8	3 5/8
3x1	1.65	1.65	3 3/8	3 5/8
3x1 1/2	1.65	1.65	3 3/8	3 5/8
3x2	1.65	1.65	3 3/8	3 5/8
3x2 1/2	1.65	1.65	3 3/8	3 5/8
4x1/2	2.11	1.65	4 1/8	4 1/8
4x3/4	2.11	1.65	4 1/8	4 1/8
4x1	2.11	1.65	4 1/8	4 1/8
4x1 1/2	2.11	1.65	4 1/8	4 1/8
4x2	2.11	1.65	4 1/8	4 1/8
4x2 1/2	2.11	1.65	4 1/8	4 1/8
4x3	2.11	1.65	4 1/8	4 1/8
6x4	2.80	2.11	5 5/8	5 5/8

卡式短三通 Instrument Tee Clamp Ends

BPE | S7RSGTMP

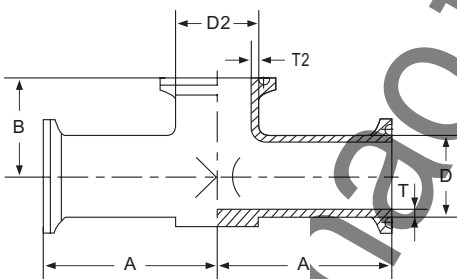

Size(inch)	T(mm)	A(inch)	B(inch)	C
1/2 x 1 1/2	1.65	3	7/8	
3/4 x 1 1/2	1.65	3	1	
1 x 1 1/2	1.65	3	1 1/8	
1/2 x 2	1.65	3 1/4	1	
3/4 x 2	1.65	3 1/4	1 1/8	
1 x 2	1.65	3 1/4	1 1/4	
1 1/2 x 2	1.65	3 1/4	1 1/2	



- ◆ Stainless Steel Sanitary Pipe Fitting
- ◆ Valve、Pump、Fluid Facility
- ◆ 不锈钢卫生级管件、阀门、泵、流体设备

一卡两焊变径短三通 Reducing Short Outlet Tee

BPE | S7RSWWK

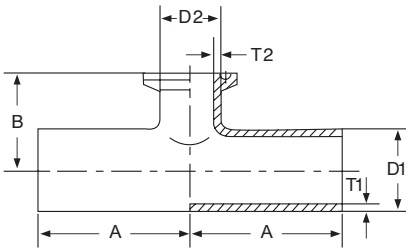

Size(inch)	T1(mm)	T2(mm)	A(inch)	B(inch)
3/4x1/2	1.65	1.65	2	
1x1/2	1.65	1.65	2 1/8	1 1/8
1x3/4	1.65	1.65	2 1/8	1 1/8
1 1/2x1/2	1.65	1.65	2 3/8	1 3/8
1 1/2x3/4	1.65	1.65	2 3/8	1 3/8
1 1/2x1	1.65	1.65	2 3/8	1 3/8
2x1/2	1.65	1.65	2 7/8	1 5/8
2x3/4	1.65	1.65	2 7/8	1 5/8
2x1	1.65	1.65	2 7/8	1 5/8
2x1 1/2	1.65	1.65	2 7/8	1 5/8
2 1/2x1/2	1.65	1.65	3 1/8	1 7/8
2 1/2x3/4	1.65	1.65	3 1/8	1 7/8
2 1/2x1	1.65	1.65	3 1/8	1 7/8
2 1/2x1 1/2	1.65	1.65	3 1/8	1 7/8
2 1/2x2	1.65	1.65	3 1/8	1 7/8
3x1/2	1.65	1.65	3 3/8	2 1/8
3x3/4	1.65	1.65	3 3/8	2 1/8
3x1	1.65	1.65	3 3/8	2 1/8
3x1 1/2	1.65	1.65	3 3/8	2 1/8
3x2	1.65	1.65	3 3/8	2 1/8
3x2 1/2	1.65	1.65	3 3/8	2 1/8
4x1/2	2.11	1.65	4 1/8	2 5/8
4x3/4	2.11	1.65	4 1/8	2 5/8
4x1	2.11	1.65	4 1/8	2 5/8
4x1 1/2	2.11	1.65	4 1/8	2 5/8
4x2	2.11	1.65	4 1/8	2 5/8
4x2 1/2	2.11	1.65	4 1/8	2 5/8
4x3	2.11	1.65	4 1/8	2 5/8
6x4	2.80	2.11	5 5/8	3 3/4

maofei



- ◆ Stainless Steel Sanitary Pipe Fitting
- ◆ Valve、Pump、Fluid Facility
- ◆ 不锈钢卫生级管件、阀门、泵、流体设备

卡式变径三通 Reducing Tee

BPE | S7RMP

SANITARY PIPE FITTINGS 卫生级管件

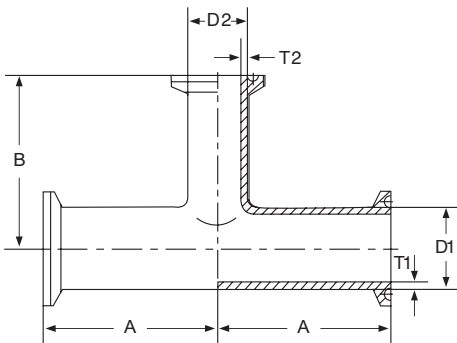

Size(inch)	T1(mm)	T2(mm)	A(inch)	B(inch)
3/4x1/2	1.65	1.65	2 1/2	2 1/2
1x1/2	1.65	1.65	2 5/8	2 5/8
1x3/4	1.65	1.65	2 5/8	2 5/8
1 1/2x1/2	1.65	1.65	2 7/8	2 7/8
1 1/2x3/4	1.65	1.65	2 7/8	2 7/8
1 1/2x1	1.65	1.65	2 7/8	2 7/8
2x1/2	1.65	1.65	3 3/8	3 1/8
2x3/4	1.65	1.65	3 3/8	3 1/8
2x1	1.65	1.65	3 3/8	3 1/8
2x1 1/2	1.65	1.65	3 3/8	3 1/8
2 1/2x1/2	1.65	1.65	3 5/8	3 3/8
2 1/2x3/4	1.65	1.65	3 5/8	3 3/8
2 1/2x1	1.65	1.65	3 5/8	3 3/8
2 1/2x1 1/2	1.65	1.65	3 5/8	3 3/8
2 1/2x2	1.65	1.65	3 5/8	3 3/8
3x1/2	1.65	1.65	3 7/8	3 5/8
3x3/4	1.65	1.65	3 7/8	3 5/8
3x1	1.65	1.65	3 7/8	3 5/8
3x1 1/2	1.65	1.65	3 7/8	3 5/8
3x2	1.65	1.65	3 7/8	3 5/8
3x2 1/2	1.65	1.65	3 7/8	3 5/8
4x1/2	2.11	1.65	4 3/4	4 1/8
4x3/4	2.11	1.65	4 3/4	4 1/8
4x1	2.11	1.65	4 3/4	4 1/8
4x1 1/2	2.11	1.65	4 3/4	4 1/8
4x2	2.11	1.65	4 3/4	4 3/8
4x2 1/2	2.11	1.65	4 3/4	4 3/8
4x3	2.11	1.65	4 3/4	4 3/8
6x4	2.80	2.11	7 1/8	5 3/4



- ◆ Stainless Steel Sanitary Pipe Fitting
- ◆ Valve、Pump、Fluid Facility
- ◆ 不锈钢卫生级管件、阀门、泵、流体设备

卡式变径短三通 Short Outlet Reducing Tee

BPE | S7RMPS

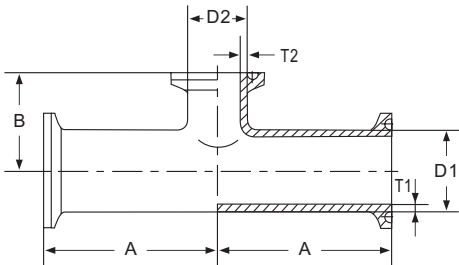

Size(inch)	T1(mm)	T2(mm)	A(inch)	B(inch)
3/4x1/2	1.65	1.65	2 1/2	1 1/8
1x1/2	1.65	1.65	2 5/8	1 1/8
1x3/4	1.65	1.65	2 5/8	1 1/8
1 1/2x1/2	1.65	1.65	2 7/8	1 3/8
1 1/2x3/4	1.65	1.65	2 7/8	1 3/8
1 1/2x1	1.65	1.65	2 7/8	1 3/8
2x1/2	1.65	1.65	3 3/8	1 5/8
2x3/4	1.65	1.65	3 3/8	1 5/8
2x1	1.65	1.65	3 3/8	1 5/8
2x1 1/2	1.65	1.65	3 3/8	1 5/8
2 1/2x1/2	1.65	1.65	3 5/8	1 7/8
2 1/2x3/4	1.65	1.65	3 5/8	1 7/8
2 1/2x1	1.65	1.65	3 5/8	1 7/8
2 1/2x1 1/2	1.65	1.65	3 5/8	1 7/8
2 1/2x2	1.65	1.65	3 5/8	1 7/8
3x1/2	1.65	1.65	3 7/8	2 1/8
3x3/4	1.65	1.65	3 7/8	2 1/8
3x1	1.65	1.65	3 7/8	2 1/8
3x1 1/2	1.65	1.65	3 7/8	2 1/8
3x2	1.65	1.65	3 7/8	2 1/8
3x2 1/2	1.65	1.65	3 7/8	2 1/8
4x1/2	2.11	1.65	4 3/4	2 5/8
4x3/4	2.11	1.65	4 3/4	2 5/8
4x1	2.11	1.65	4 3/4	2 5/8
4x1 1/2	2.11	1.65	4 3/4	2 5/8
4x2	2.11	1.65	4 3/4	2 5/8
4x2 1/2	2.11	1.65	4 3/4	2 5/8
4x3	2.11	1.65	4 3/4	2 5/8
6x4	2.80	2.11	7 1/8	3 3/4

焊式四通 Cross

BPE | S9WWWW

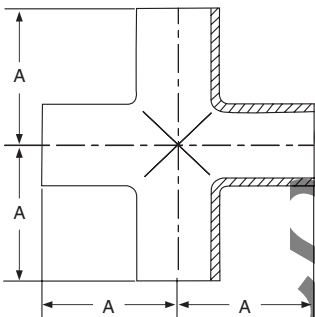

Size(inch)	T(mm)	A(inch)	B	C
1/2	1.65	1 7/8		
3/4	1.65	2		
1	1.65	2 1/8		
1 1/2	1.65	2 3/8		
2	1.65	2 7/8		
2 1/2	1.65	3 1/8		
3	1.65	3 3/8		
4	2.11	4 1/8		
6	2.8	5 5/8		



- ◆ Stainless Steel Sanitary Pipe Fitting
- ◆ Valve、Pump、Fluid Facility
- ◆ 不锈钢卫生级管件、阀门、泵、流体设备

卡式等径四通 Cross ends Ferrule

BPE | S9MP

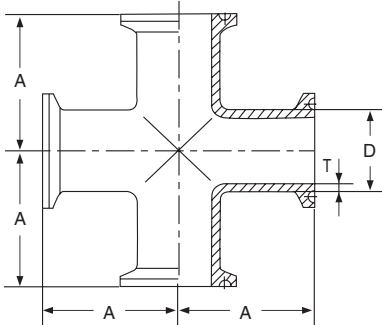

Size(inch)	T(mm)	A(inch)	B	C
1/2	1.65	2 1/4		
3/4	1.65	2 3/8		
1	1.65	2 5/8		
1 1/2	1.65	2 7/8		
2	1.65	3 3/8		
2 1/2	1.65	3 5/8		
3	1.65	3 7/8		
4	2.11	4 3/8		
6	2.8	7 1/8		

焊式变径四通 Reducing Cross

BPE | S9RWWWW

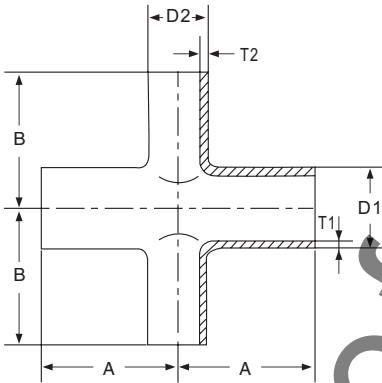

Size(inch)	T1(mm)	T2(mm)	A(inch)	B(inch)
3/4x1/2	1.65	1.65	2	2
1x1/2	1.65	1.65	2 1/8	2 1/8
1x3/4	1.65	1.65	2 1/8	2 1/8
1 1/2x1/2	1.65	1.65	2 3/8	2 3/8
1 1/2x3/4	1.65	1.65	2 3/8	2 3/8
1 1/2x1	1.65	1.65	2 3/8	2 3/8
2x1/2	1.65	1.65	2 7/8	2 5/8
2x3/4	1.65	1.65	2 7/8	2 5/8
2x1	1.65	1.65	2 7/8	2 5/8
2x1 1/2	1.65	1.65	2 7/8	2 5/8
2 1/2x1/2	1.65	1.65	3 1/8	2 7/8
2 1/2x3/4	1.65	1.65	3 1/8	2 7/8
2 1/2x1	1.65	1.65	3 1/8	2 7/8
2 1/2x1 1/2	1.65	1.65	3 1/8	2 7/8
2 1/2x2	1.65	1.65	3 1/8	2 7/8
3x1/2	1.65	1.65	3 3/8	3 1/8
3x3/4	1.65	1.65	3 3/8	3 1/8
3x1	1.65	1.65	3 3/8	3 1/8
3x1 1/2	1.65	1.65	3 3/8	3 1/8
3x2	1.65	1.65	3 3/8	3 1/8
3x2 1/2	1.65	1.65	3 3/8	3 1/8
4x1/2	2.11	1.65	4 1/8	3 5/8
4x3/4	2.11	1.65	4 1/8	3 5/8
4x1	2.11	1.65	4 1/8	3 5/8
4x1 1/2	2.11	1.65	4 1/8	3 5/8
4x2	2.11	1.65	4 1/8	3 5/8
4x2 1/2	2.11	1.65	4 1/8	3 5/8
4x3	2.11	1.65	4 1/8	3 5/8
6x4	2.80	2.11	4 1/8	3 5/8



- ◆ Stainless Steel Sanitary Pipe Fitting
- ◆ Valve、Pump、Fluid Facility
- ◆ 不锈钢卫生级管件、阀门、泵、流体设备

焊式同心变径 Concentric Reducer

| BPE | S31

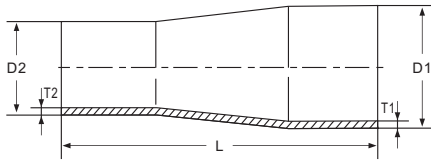

Size(inch)	T1(mm)	T2(mm)	L(inch)	B
3/4x1/2	1.65	1.65	4	
1x1/2	1.65	1.65	4 1/2	
1x3/4	1.65	1.65	4 1/2	
1 1/2x1/2	1.65	1.65	5 1/2	
1 1/2x3/4	1.65	1.65	5	
1 1/2x1	1.65	1.65	5	
2x1/2	1.65	1.65	7 3/4	
2x3/4	1.65	1.65	7 1/4	
2x1	1.65	1.65	7 1/4	
2x1 1/2	1.65	1.65	5 1/4	
2 1/2x1/2	1.65	1.65	9 3/4	
2 1/2x3/4	1.65	1.65	9 1/4	
2 1/2x1	1.65	1.65	9 1/4	
2 1/2x1 1/2	1.65	1.65	7 1/4	
2 1/2x2	1.65	1.65	5 1/2	
3x1	1.65	1.65	11 1/4	
3x1 1/2	1.65	1.65	9 1/4	
3x2	1.65	1.65	7 1/2	
3x2 1/2	1.65	1.65	5 1/2	
4x1	2.11	1.65	15 1/2	
4x1 1/2	2.11	1.65	13 1/2	
4x2	2.11	1.65	11 3/4	
4x2 1/2	2.11	1.65	9 3/4	
4x3	2.11	1.65	7 3/4	
6x4	2.8	2.11	10	

焊式偏心变径 Eccentric Reducer

| BPE | S32

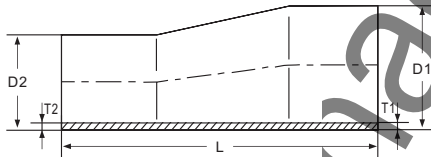

Size(inch)	T1(mm)	T2(mm)	L(inch)	B
3/4x1/2	1.65	1.65	4	
1x1/2	1.65	1.65	4 1/2	
1x3/4	1.65	1.65	4 1/2	
1 1/2x1/2	1.65	1.65	5 1/2	
1 1/2x3/4	1.65	1.65	5	
1 1/2x1	1.65	1.65	5	
2x1/2	1.65	1.65	7 3/4	
2x3/4	1.65	1.65	7 1/4	
2x1	1.65	1.65	7 1/4	
2x1 1/2	1.65	1.65	5 1/4	
2 1/2x1/2	1.65	1.65	9 3/4	
2 1/2x3/4	1.65	1.65	9 1/4	
2 1/2x1	1.65	1.65	9 1/4	
2 1/2x1 1/2	1.65	1.65	7 1/4	
2 1/2x2	1.65	1.65	5 1/2	
3x1	1.65	1.65	11 1/4	
3x1 1/2	1.65	1.65	9 1/4	
3x2	1.65	1.65	7 1/2	
3x2 1/2	1.65	1.65	5 1/2	
4x1	2.11	1.65	15 1/2	
4x1 1/2	2.11	1.65	13 1/2	
4x2	2.11	1.65	11 3/4	
4x2 1/2	2.11	1.65	9 3/4	
4x3	2.11	1.65	7 3/4	
6x4	2.8	2.11	10	



- ◆ Stainless Steel Sanitary Pipe Fitting
- ◆ Valve、Pump、Fluid Facility
- ◆ 不锈钢卫生级管件、阀门、泵、流体设备

一卡一焊式同心变径 Concentric Reducer/Ferrule Large end

BPE | S31K

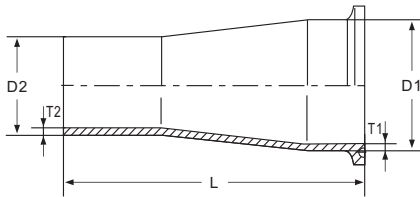

Size(inch)	T1(mm)	T2(mm)	L(inch)	B
3/4x1/2	1.65	1.65	3	
1x1/2	1.65	1.65	3 1/2	
1x3/4	1.65	1.65	3	
1 1/2x1/2	1.65	1.65	4 1/2	
1 1/2x3/4	1.65	1.65	4	
1 1/2x1	1.65	1.65	4	
2x1/2	1.65	1.65	6 1/2	
2x3/4	1.65	1.65	6	
2x1	1.65	1.65	6	
2x1 1/2	1.65	1.65	4	
2 1/2x1/2	1.65	1.65	8 1/2	
2 1/2x3/4	1.65	1.65	8	
2 1/2x1	1.65	1.65	8	
2 1/2x1 1/2	1.65	1.65	6	
2 1/2x2	1.65	1.65	4 1/4	
3x1	1.65	1.65	10	
3x1 1/2	1.65	1.65	8	
3x2	1.65	1.65	6 1/4	
3x2 1/2	1.65	1.65	4 1/4	
4x1	2.11	1.65	14 1/8	
4x1 1/2	2.11	1.65	12 1/8	
4x2	2.11	1.65	10 3/8	
4x2 1/2	2.11	1.65	8 3/8	
4x3	2.11	1.65	6 3/8	
6x4	2.8	2.11	9	

一卡一焊式偏心变径 Eccentric Reducer/Ferrule Large end

BPE | S32K

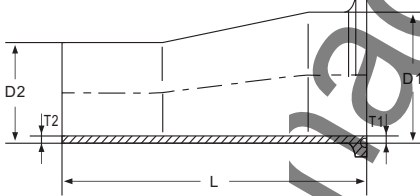

Size(inch)	T1(mm)	T2(mm)	L(inch)	B
3/4x1/2	1.65	1.65	3	
1x1/2	1.65	1.65	3 1/2	
1x3/4	1.65	1.65	3	
1 1/2x1/2	1.65	1.65	4 1/2	
1 1/2x3/4	1.65	1.65	4	
1 1/2x1	1.65	1.65	4	
2x1/2	1.65	1.65	6 1/2	
2x3/4	1.65	1.65	6	
2x1	1.65	1.65	6	
2x1 1/2	1.65	1.65	4	
2 1/2x1/2	1.65	1.65	8 1/2	
2 1/2x3/4	1.65	1.65	8	
2 1/2x1	1.65	1.65	8	
2 1/2x1 1/2	1.65	1.65	6	
2 1/2x2	1.65	1.65	4 1/4	
3x1	1.65	1.65	10	
3x1 1/2	1.65	1.65	8	
3x2	1.65	1.65	6 1/4	
3x2 1/2	1.65	1.65	4 1/4	
4x1	2.11	1.65	14 1/8	
4x1 1/2	2.11	1.65	12 1/8	
4x2	2.11	1.65	10 3/8	
4x2 1/2	2.11	1.65	8 3/8	
4x3	2.11	1.65	6 3/8	
6x4	2.8	2.11	9	

SANITARY PIPE FITTINGS 卫生级管件



- ◆ Stainless Steel Sanitary Pipe Fitting
- ◆ Valve、Pump、Fluid Facility
- ◆ 不锈钢卫生级管件、阀门、泵、流体设备

卡式同心变径 Concentric Reducer

BPE | S31-14MP

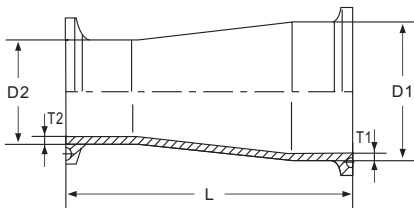

Size(inch)	T1(mm)	T2(mm)	L(inch)	B
3/4x1/2	1.65	1.65	2	
1x1/2	1.65	1.65	2 1/2	
1x3/4	1.65	1.65	2	
1 1/2x1/2	1.65	1.65	3 1/2	
1 1/2x3/4	1.65	1.65	3	
1 1/2x1	1.65	1.65	3	
2x1/2	1.65	1.65	5 1/2	
2x3/4	1.65	1.65	5	
2x1	1.65	1.65	5	
2x1 1/2	1.65	1.65	3	
2 1/2x1/2	1.65	1.65	7 1/2	
2 1/2x3/4	1.65	1.65	7	
2 1/2x1	1.65	1.65	7	
2 1/2x1 1/2	1.65	1.65	5	
2 1/2x2	1.65	1.65	3	
3x1	1.65	1.65	9	
3x1 1/2	1.65	1.65	7	
3x2	1.65	1.65	5	
3x2 1/2	1.65	1.65	3	
4x1	2.11	1.65	13 1/8	
4x1 1/2	2.11	1.65	11 1/8	
4x2	2.11	1.65	9 1/8	
4x2 1/2	2.11	1.65	7 1/8	
4x3	2.11	1.65	5 1/8	
6x4	2.8	2.11	7 5/8	

卡式偏心变径 Eccentric Reducer

BPE | S32-14MP

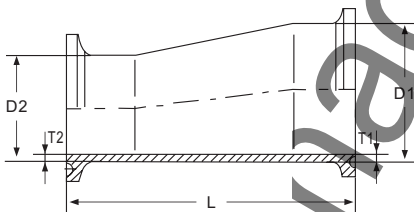

Size(inch)	T1(mm)	T2(mm)	L(inch)	B
3/4x1/2	1.65	1.65	2	
1x1/2	1.65	1.65	2 1/2	
1x3/4	1.65	1.65	2	
1 1/2x1/2	1.65	1.65	3 1/2	
1 1/2x3/4	1.65	1.65	3	
1 1/2x1	1.65	1.65	3	
2x1/2	1.65	1.65	5 1/2	
2x3/4	1.65	1.65	5	
2x1	1.65	1.65	5	
2x1 1/2	1.65	1.65	3	
2 1/2x1/2	1.65	1.65	7 1/2	
2 1/2x3/4	1.65	1.65	7	
2 1/2x1	1.65	1.65	7	
2 1/2x1 1/2	1.65	1.65	5	
2 1/2x2	1.65	1.65	3	
3x1	1.65	1.65	9	
3x1 1/2	1.65	1.65	7	
3x2	1.65	1.65	5	
3x2 1/2	1.65	1.65	3	
4x1	2.11	1.65	13 1/8	
4x1 1/2	2.11	1.65	11 1/8	
4x2	2.11	1.65	9 1/8	
4x2 1/2	2.11	1.65	7 1/8	
4x3	2.11	1.65	5 1/8	
6x4	2.8	2.11	7 5/8	