

# ESTIC



OK  
NG

T/T

SERVO PRESS

# SERVO PRESS

SI

RS485-NET

RS232C

CHARGE



MOTOR



# Energy saving / Clean and quiet working

**ESTIC develops and provides high quality and accurate products using advanced servo and digital technology.**

## Environmental consideration

Reduction of energy consumption and noise with superior features of a Servo motor drive. (Energy consumption is approx 10~20 % less energy in comparison with air or oil powered presses.)

## Improvement of production

Controlling load, position, speed, and time with high accuracy optimizes production cycle time.  
Feeding back real time operation conditions prevents damaging work object.

## Safety Design

Internal brake holds ram from free fall in case of power failure.

## Easy setup

System configuration is simple consisting of tool, controller, cable.  
User friendly parameter input enables short setup times.  
(High accuracy load cell and resolver are used)

## Traceability

A large range of data is collected allowing for full traceability.

## 4 modes of control

Entering one of the four control modes and inputting the required parameters are the only steps in programming the system. Using the management software (option) enables shorter start-up time.

### ▶ Load control & Position monitor

Load control until Target (Upper/Lower limit Judgment)  
With Position and Motion time monitor (Upper/Lower limit Judgment)

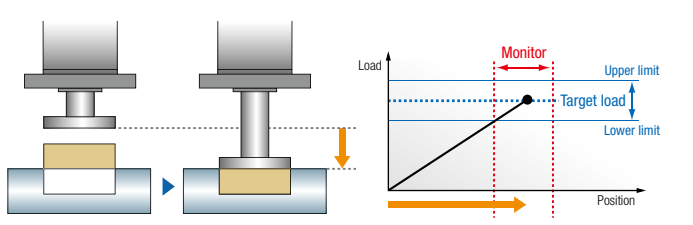

### ▶ Position control & Load monitor

Position control until Target (Upper/Lower limit Judgment)  
With Load and Motion time monitor (Upper/Lower limit Judgment)

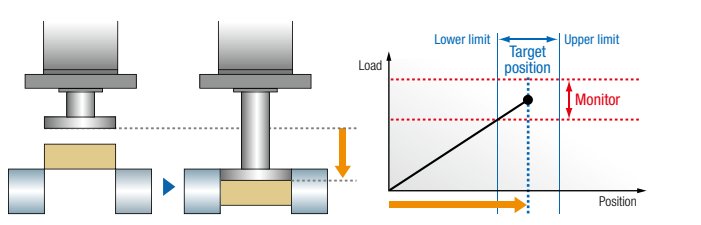

### ▶ Increment control

Position control from SNUG point to Target (Upper/Lower limit Judgment)  
With Load and Motion time monitor (Upper/Lower limit Judgment)

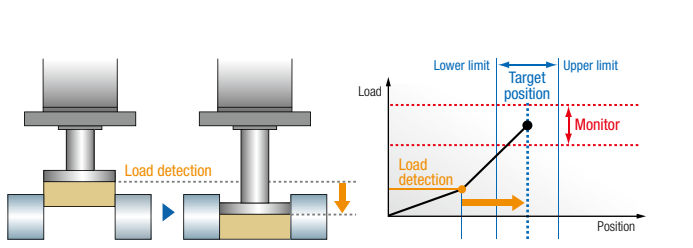

### ▶ Load control & Increment control

Load control and Position control from SNUG point to Target (Upper/Lower limit Judgment)  
With Load/Position and Motion time monitor (Upper/Lower limit Judgment)

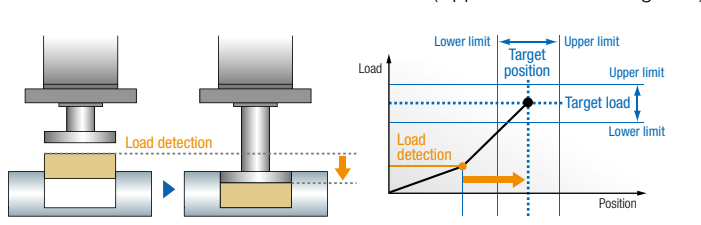

## Dynamic Slope / Stall function

Motion control of servo motor directory reads the real time feed-back load condition from press tool. This function is able to keep a constant load pressure by checking & controlling fluctuating load of application.

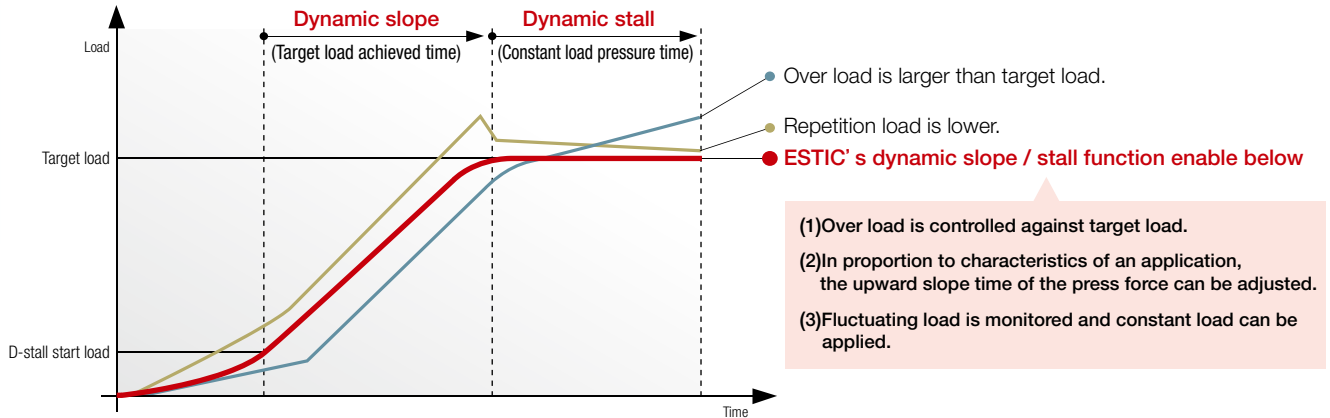

## Back monitor function (range judgment)

This function can judge using the upper & lower load limits at any position of the pressing process. Monitoring a range based on the end of the process avoids judgments influenced by the scattering of position readings or equipment fatigue.

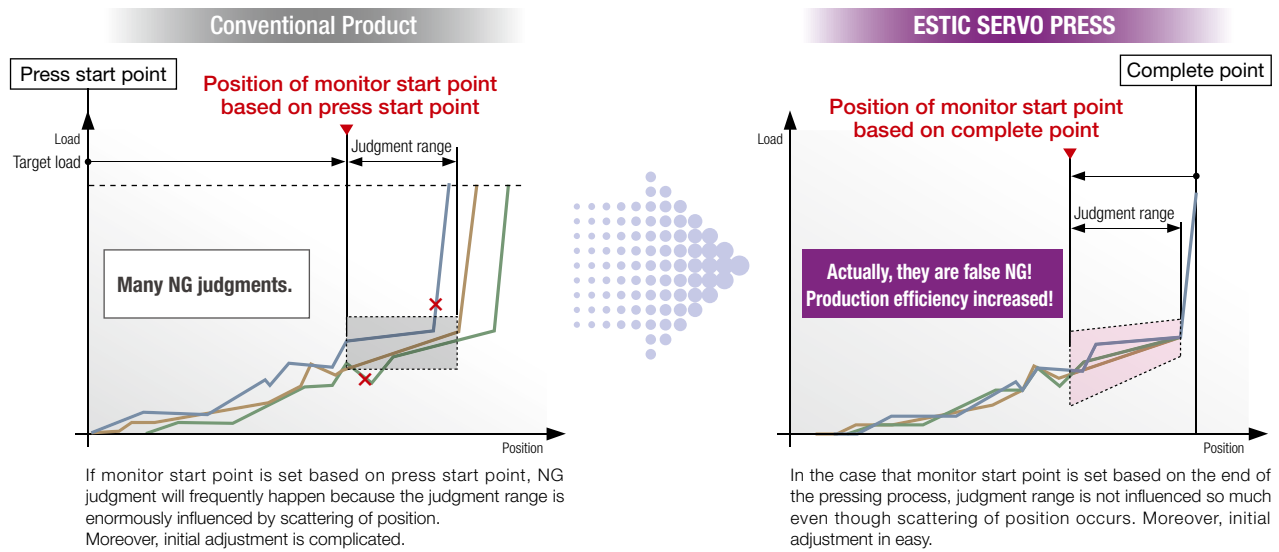

## Application

**Press-In**  
Bearing, Valve Guide,  
Valve Seat, Plug,  
Bush, Pin, etc

**Crimping**

**Straightening**



**Fitting**

**Punching**

**Positioning**

## ■ Press tool

Model Name*1	SPT005-20	SPT010-25	SPT020-25	SPT030-25	SPT050-30	SPT100-30	SPH100-30
Pressing Capability (kN)	5	10	20	30	50	100	
Consecutive PressRate (kN)	2.1	4.2	5.6	6.9	10.2	52.4	100
Max. Stroke (mm)*2	200	250			300		
Max. Feed Speed (mm/sec)	345	310	225	200	121	114	44
Max. Press-in Speed (mm/sec)	80	76	60	46	27	85	33
Repeatability (mm)	±0.01						
Press Repeat Accuracy	3σ/̄X = 2% or lower						
Size (mm)	A (mm)	541	676	724	777.5	924	1175
	B (mm)	199	228	245	265	305	503
	C (mm)	80	100	110	130	160	250
Weight (kg)	16	39	44	70	115	352	
Control unit to be combined	SPU45-20	SPU45-40			SPU45-5K		

\*1 SPT100-30 (High-Speed type) and SPT100-30 (Consecutive press type) are MTO.

\*2 For detail such as changing stroke length, please contact the person in charge at our company.

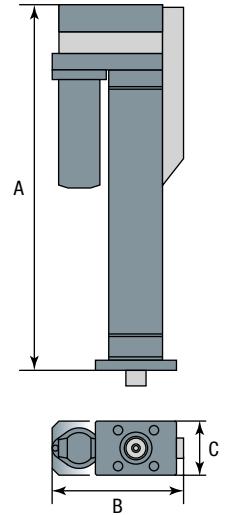

## ■ Control unit

Controller model	SPU45-20	SPU45-40	SPU45-5K
Control Supply	Single Phase AC200~230V±10% 50/60 Hz		
Power Supply	Three Phase AC200~230V±10% 50/60 Hz		
Main power capacity (At rated operation)	1.2kVA	1.7kVA	5.4kVA
Size (mm)	W (mm)	87	116
	H (mm)	255	274.5
	D (mm)	205	210
Weight (kg)	3.2	3.4	3.5

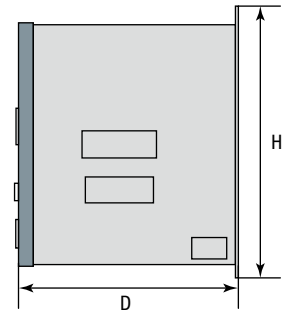
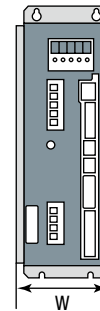

## ■ System Diagram

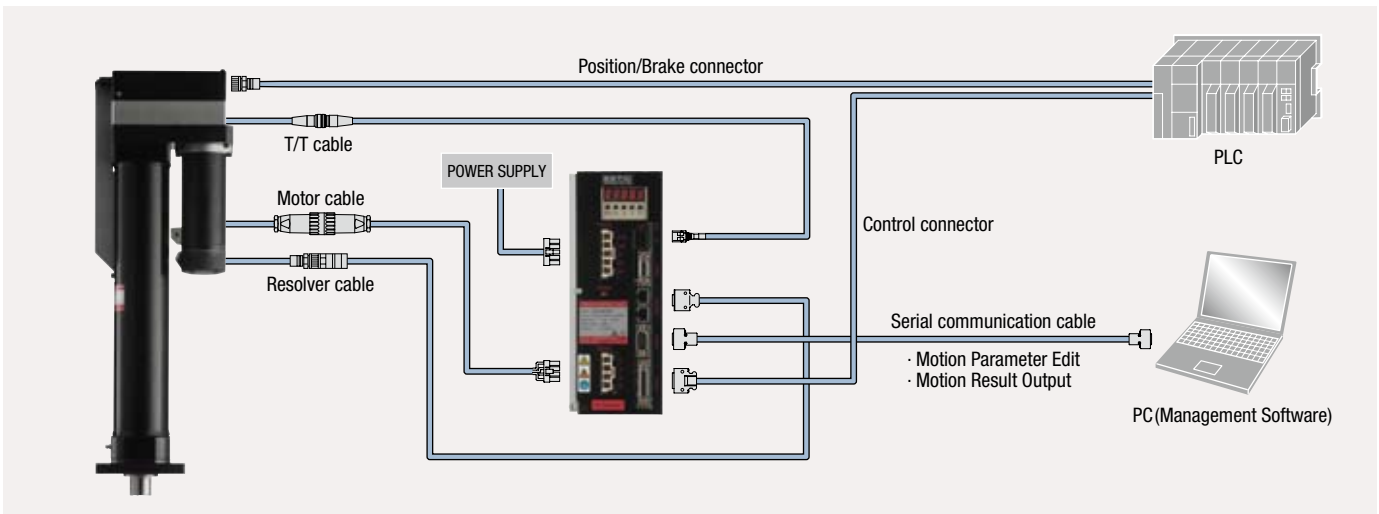

# ESTIC

**Estic Corporation**

URL <http://www.estic.co.jp>



JQA-2805

**Headquarters/Plant** 2-5-9 Hashibahigashino-cho Moriguchi-city Osaka, Pref.570-0031, Japan  
PHONE:81(6)6993-8855 FAX:81(6)6993-8881  
E-MAIL [osaka\\_office@estic.co.jp](mailto:osaka_office@estic.co.jp)

**Tokyo Office** Shinyokohama Narita Bldg. 6F 2-12-3, Shinyokohama Kouhoku-ku  
Yokohama-city Kanagawa, Pref.222-0033, Japan  
PHONE:81(45)474-3036 FAX:81(45)474-3037  
E-MAIL [tokyo\\_office@estic.co.jp](mailto:tokyo_office@estic.co.jp)

**Chubu Office** Yamahichi Higashiokazaki Bldg. 4F 19-13, Aza Kawabata Myodaiji Okazaki-city Aichi, Pref.444-0864, Japan  
PHONE:81(564)66-0510 FAX:81(564)66-0515  
E-MAIL [chubu\\_office@estic.co.jp](mailto:chubu_office@estic.co.jp)

**Shanghai Estic Corp.** PHONE:86(21)-68130333 FAX:86(21)-68130777  
E-MAIL [ecc@estic.cn](mailto:ecc@estic.cn)



- The colors of the products may slightly differ from those of the actual products, which is inevitable in printing.
- Recycle paper is used for the catalog for environmental conservation.
- The specifications and designs of the products may be changed without previous notice.



This catalog is printed by environment friendly vegetable soybeans oil ink.

The contents of the catalog are as of February, 2009.