



MODEL NO : P1210XGF1MA00

SPEC VERSION : V1.2

ISSUED DATE: 2021-4-14

Preliminary Specification

Final Product Specification

Customer : _____

Approved by	Notes

TIANMA Confirmed :

Prepared by	Checked by	Approved by
Chunhui.Yang	Longping.Deng	

This technical specification is subjected to change without notice



Table of Contents

Table of Contents	2
Record of Revision.....	3
1 General Specifications.....	4
2 Input/Output Terminals	5
3 Absolute Maximum Ratings.....	7
4 Electrical Characteristics	8
5 Timing Chart.....	10
6 Optical Characteristics	12
7 Environmental / Reliability Test.....	16
8 Mechanical Drawing	17
9 Packing Drawing	18
10 Precautions For Use of LCD Modules	19



1 General Specifications

	Feature	Spec
Display Spec.	Size	12.1 inch
	Resolution	1024(RGB) x 768
	Technology Type	SFT
	Pixel Configuration	R.G.B. Vertical Stripe
	Pixel Pitch (mm)	0.240 (H) × 0.240 (V)
	Display Mode	Transmissive, Normally Black
	Surface Treatment(Up Polarizer)	AG
	Viewing Direction	All direction
Mechanical Characteristics	LCM (W x H x D) (mm)	260.5x203x9.5
	Active Area(mm)	245.76*184.32
	With /Without TSP	Without Touch Screen
	Matching Connection Type	CN1: FI-S20S CN2: SHLP-10V-S-B
	Weight (g)	(550g)
Electrical Characteristics	Interface	1port LVDS 8bit
	Color Depth	16.7M&262K

Note 1: Viewing direction for best image quality is different from TFT definition, there is a 180 degree shift.

Note 2 : Requirements on Environmental Protection: Q/S0002

Note 3 : LCM weight tolerance : +/- 5%



2 Input/Output Terminals

2.1 TFT LCD Panel (CN1)

Connector type: FI-SEB20P-HFE(JAE)

Matching connector: FI-S20S, FI-SE20-ME(JAE)

Pin No.	Symbol	I/O	Function	Remark
1	Vcc	P	+3.3V Power supply	
2	Vcc	P	+3.3V Power supply	
3	GND	P	Ground	
4	GND	P	Ground	
5	D0-	I	LVDS Channel 0-	
6	D0+	I	LVDS Channel 0+	
7	GND	P	Ground	
8	D1-	I	LVDS Channel 1-	
9	D1+	I	LVDS Channel 1+	
10	GND	P	Ground	
11	D2-	I	LVDS Channel 2-	
12	D2+	I	LVDS Channel 2+	
13	GND	P	Ground	
14	CLK-	I	LVDS Clock-	
15	CLK+	I	LVDS Clock+	
16	GND	P	Ground	
17	D3-	I	LVDS Channel3-	
18	D3+	I	LVDS Channel3+	
19	MODE	I	Low=ISP 6bit compatibility mode High=ISP 8bit compatibility mode	
20	SC	I	Scan direction control (Low: Normal High: Reverse)	

Note1: I/O definition. I---Input pin, O---Output pin, P--- Power/Ground, N--- No Connection

**2.1 Backlight (CN2)****Connector type:** SM10B-SHLS-TF(LF)(SN)(JST)**Matching connector:** SHLP-10V-S-B(JST)

No	Symbol	I/O	Description	Remarks
1	NC	N	This pin should be open	
2	NC	N	This pin should be open	
3	LEDC1	P	Cathode 1	
4	LEDA1	P	Anode 1	
5	LEDA2	P	Anode 2	
6	LEDC2	P	Cathode 2	
7	LEDC3	P	Cathode 3	
8	LEDA3	P	Anode 3	
9	LEDA4	P	Anode 4	
10	LEDC4	P	Cathode 4	

I/O definition:

I----Input O----Output P----Power/Ground N—No Connect



3 Absolute Maximum Ratings

3.1 Driving TFT LCD Panel

GND=0V

Item	Symbol	MIN	MAX	Unit	Remark
Voltage Input	V _{in}	-0.50	5.00	V	Note1
Operating Temperature	T _{op}	-30.0	80.0	°C	
Storage Temperature	T _{st}	-40.0	90.0	°C	
Relative Humidity (Note2)	RH	--	≤95	%	Ta ≤ 40°C
		--	≤85	%	40°C < Ta ≤ 50°C
		--	≤55	%	50°C < Ta ≤ 60°C
		--	≤36	%	60°C < Ta ≤ 70°C
		--	≤24	%	70°C < Ta ≤ 80°C
Absolute Humidity	AH	--	≤70	g/m ³	Ta > 70°C

Table 3.1 absolute maximum rating

Note1: The parameter is for driver IC (gate driver, source driver) only.

Note2: Ta means the ambient temperature.

It is necessary to limit the relative humidity to the specified temperature range.
Condensation on the module is not allowed.



4 Electrical Characteristics

4.1 Driving TFT LCD Panel

VCC=3.3V,GND=0V, Ta=25°C

Item	Symbol	MIN	TYP	MAX	Unit	Remark
Power supply Voltage	VDD	-	3.3	-	V	
Power supply ripple	Vp-p	-	-	-	mV	
Power supply current	IDD	-	-	-	mA	
LCD power consumption	P	-	(1200)	-	mW	
Gate On Voltage	VGH	-	23	-	V	
Gate On Voltage	VGL	-	-7	-	V	
Differential input voltage	Vid	-	-	-	mV	
Power For Analog Circuit	AVDD	-	(12.5)	-	V	
Logic Input Voltage	Low level	VIL	0	-	0.3VDD	mV
	High level	ViH	0.7VDD	-	VDD	mV
Inrush current	Irush	-	-	-	A	

4.2 Driving Backlight

Ta=25°C

Item	Symbol	Min	Typ	Max	Unit	Remark
Forward Current Voltage (per string)	V _F	--	21.7	23.8	V	
Forward Current(per string)	I _F	--	115	--	mA	
Backlight Power Consumption	W _{BL}	--	9982	10948	mW	
LED life time	--	80000	100000	--	Hrs	

Note 1: The figure below shows the connection of backlight LED.

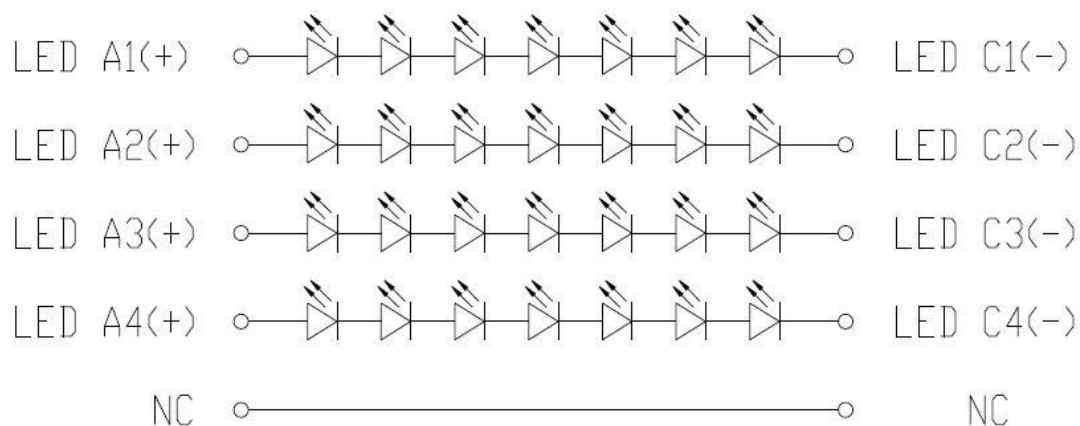



4.3 Block Diagram

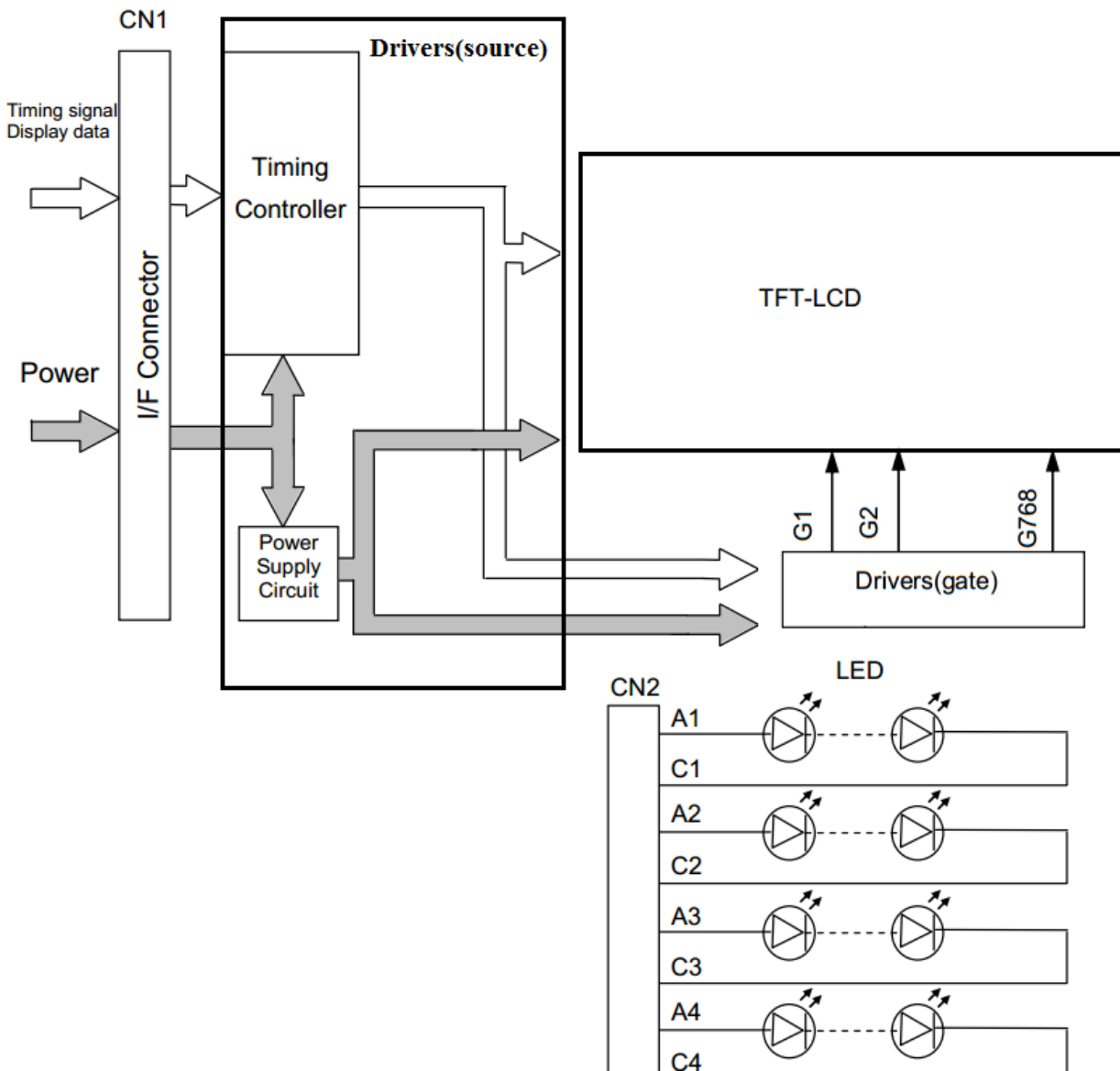



5 Timing Chart

5.1 LVDS data input format

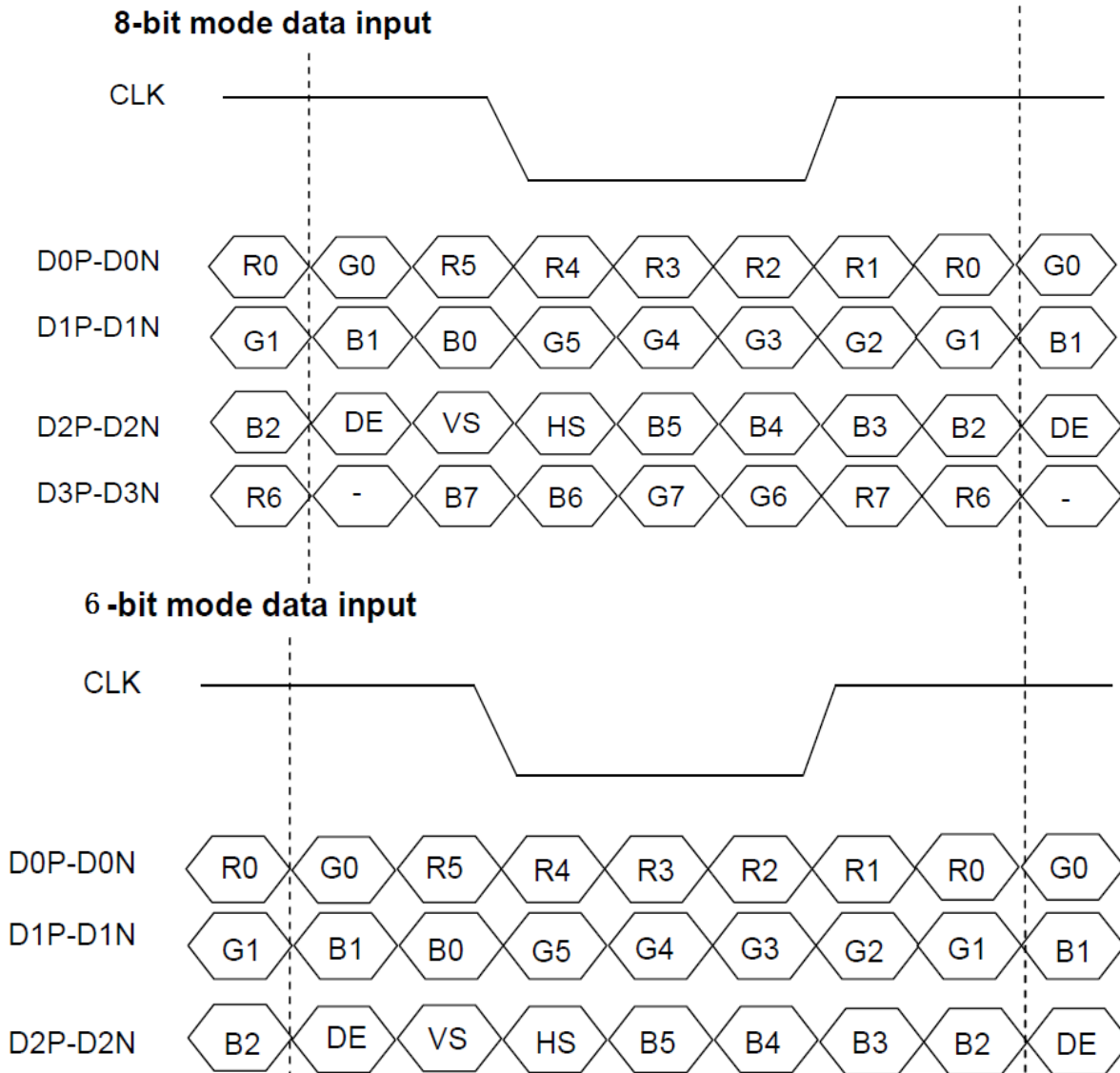

Figure 5.1.1 LVDS data input format (VESA standard)



DE mode for 1024RGB*768

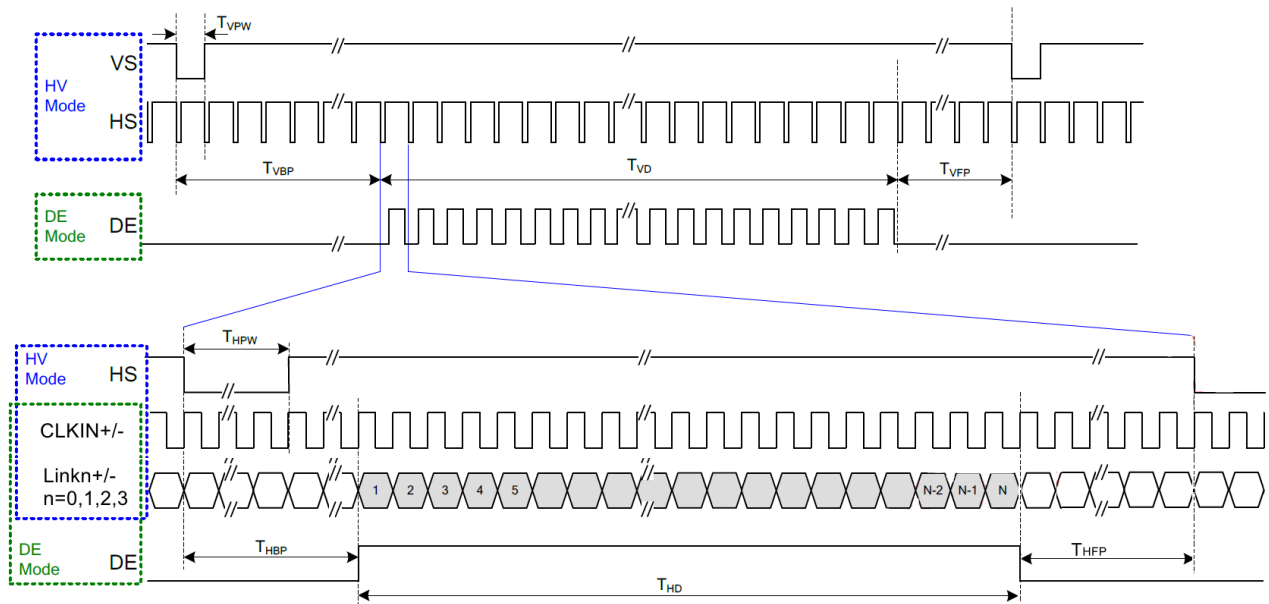

Figure5.1.2 Recommended input timing of LVDS transmitter

Note1: As shown in the figure above, the customer only needs to look at the DE mode section , instead of the SYNC section.

Parameter	Symbol	Min.	Typ.	Max.	Unit
CLK frequency	F_{CLK}	50.34	50.66	80	MHz
Horizontal display area	T_{HD}	1024			CLK
HS period time	T_H	1084	1088	1214	CLK
HS blanking	$T_{HFP}+T_{HBP}$	60	64	190	CLK
Vertical display area	T_{VD}	768			H
VS period time	T_V	774	776	897	H
VS blanking	$T_{VBP}+T_{VFP}$	6	8	129	H
Frame rate	FR	60			Hz

DE mode for 1024RGB*768

Figure5.1.3 LVDS data parameters



6 Optical Characteristics

6.1 Optical Specification

Ta=25°C

Item	Symbol	Condition	Min	Typ	Max	Unit	Remark	
View Angles	θT	$CR \cong 10$	80	88	-	Degree	Note 2	
	θB		80	88	-			
	θL		80	88	-			
	θR		80	88	-			
Contrast Ratio	CR	$\theta=0^\circ$	800	1000	-	-	Note1 Note3	
Response Time	$T_{ON}+T_{OFF}$	25°C	-	25	35	ms	Note1 Note4	
Chromaticity	White	Backlight is on	x		TBD		-	Note5 Note1
			y		TBD			
	Red		x		TBD			
			y		TBD			
	Green		x		TBD			
			y		TBD			
	Blue		x		TBD			
			y		TBD			
Uniformity	U	-	75	80	-	%	Note1 Note6	
NTSC	-	-	67	72	-	%	Note 5	
Luminance	L	-	1000	1300	-	cd/m ²	Note1	

Test Conditions:

1. The ambient temperature is 25±2°C. humidity is 65±7%
2. The test systems refer to Note 1 and Note 2.



Note 1: Definition of optical measurement system.

The optical characteristics should be measured in dark room. After 5 minutes operation, the optical properties are measured at the center point of the LCD screen. All input terminals LCD panel must be ground when measuring the center area of the panel.

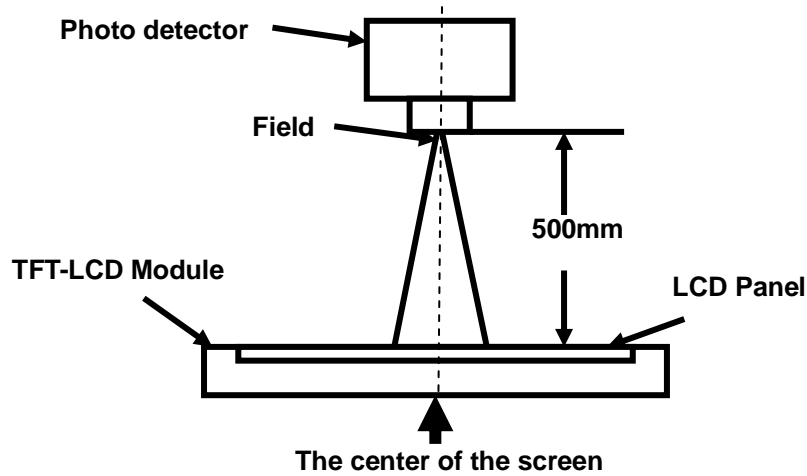

Note 2: Definition of viewing angle range and measurement system.

viewing angle is measured at the center point of the LCD by CONOSCOPE(ergo-80).

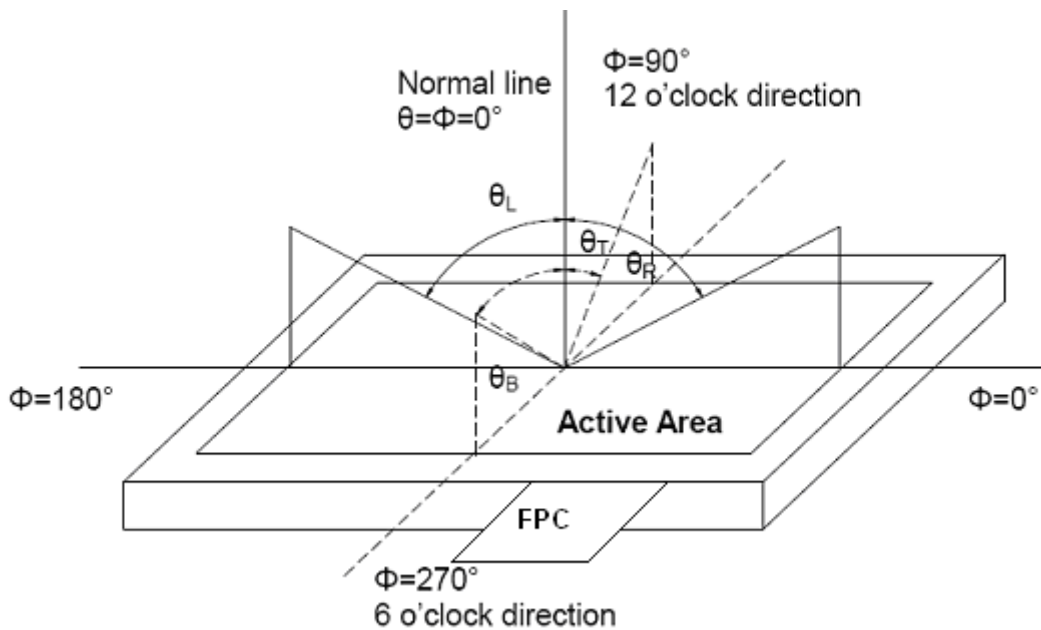

Fig. 1 Definition of viewing angle



Note 3: Definition of contrast ratio

$$\text{Contrast ratio (CR)} = \frac{\text{Luminance measured when LCD is on the "White" state}}{\text{Luminance measured when LCD is on the "Black" state}}$$

"White state": The state is that the LCD should driven by V_{white} .

"Black state": The state is that the LCD should driven by V_{black} .

V_{white} : To be determined V_{black} : To be determined.

Note 4: Definition of Response time

The response time is defined as the LCD optical switching time interval between "White" state and "Black" state. Rise time (T_{ON}) is the time between photo detector output intensity changed from 90% to 10%. And fall time (T_{OFF}) is the time between photo detector output intensity changed from 10% to 90%.

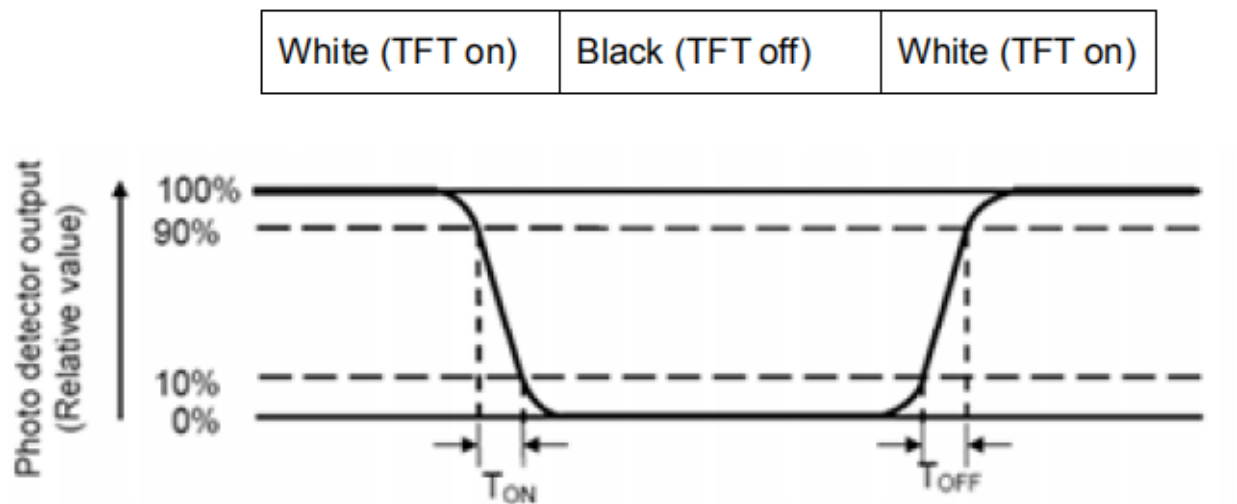

Note 5: Definition of color chromaticity (CIE1931)

Color coordinates measured at center point of LCD.



Note 6: Definition of Luminance Uniformity

Active area is divided into 9 measuring areas (Refer Fig. 2). Every measuring point is placed at the center of each measuring area.

$$\text{Luminance Uniformity}(U) = L_{\min} / L_{\max}$$

L-----Active area length W----- Active area width

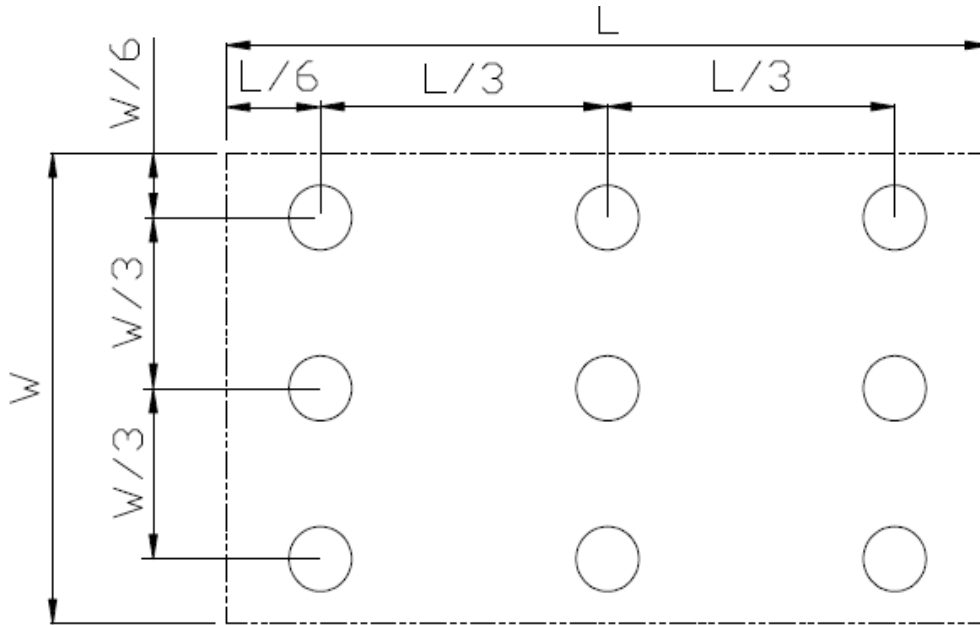

Fig. 2 Definition of uniformity

Lmax: The measured maximum luminance of all measurement position.

Lmin: The measured minimum luminance of all measurement position.

Note 7: Definition of Luminance :

Measure the luminance of white state at center point.



7 Environmental / Reliability Test

No	Test Item	Condition	Remark
1	High Temperature Operation	Ta = +80°C, 240 hours	IEC60068-2-1 GB2423.2
2	Low Temperature Operation	Ta = -30°C, 240 hours	IEC60068-2-1 GB2423.1
3	High Temperature Storage	Ta = +90°C, 240 hours	IEC60068-2-1 GB2423.2
4	Low Temperature Storage	Ta = -40°C, 240 hours	IEC60068-2-1 GB2423.1
5	High Temperature & High Humidity Operation	Ta = +60°C, 90% RH max, 240 hours	IEC60068-2-78 GB/T2423.3
6	Thermal Shock (non-operation)	-30°C 30 min~+80°C 30 min, Change time:5min, 100 Cycle	Start with cold temperature, End with high temperature, IEC60068-2-14, GB2423.22
7	ESD	C=150pF, R=330Ω, 9point/panel Air:±15Kv, 5times; Contact:±8Kv, 5times (Environment: 15°C~35°C, 30%~60%.86Kpa~106Kpa)	IEC61000-4-2 GB/T17626.2
8	Vibration Test (Non Op)	5~100HZ, 19.60m/s ² 1min/cycle 120times Per XYZ	IEC60068-2-6 GB/T17626.6
9	Mechanical Shock (Non Op)	539m/s ² , 11ms 5times ±X、±Y、±Z	IEC60068-2-27 GB/T2423.5

Note1: Ts is the temperature of panel's surface.

Note2: Ta is the ambient temperature of sample.

Note3: Before cosmetic and function test, the product must have enough recovery time, at least 2 hours at room temperature.

Note 4: In the standard condition, there shall be no practical problem that may affect the display function. After the reliability test, the product only guarantees operation, but don't guarantee all of the cosmetic specification.



9 Packing Drawing



10 Precautions For Use of LCD Modules

10.1 Handling Precautions

- 10.1.1 The display panel is made of glass. Do not subject it to a mechanical shock by dropping it from a high place, etc.
- 10.1.2 If the display panel is damaged and the liquid crystal substance inside it leaks out, be sure not to get any in your mouth, if the substance comes into contact with your skin or clothes, promptly wash it off using soap and water.
- 10.1.3 Do not apply excessive force to the display surface or the adjoining areas since this may cause the color tone to vary.
- 10.1.4 The polarizer covering the display surface of the LCD module is soft and easily scratched. Handle this polarizer carefully.
- 10.1.5 If the display surface is contaminated, breathe on the surface and gently wipe it with a soft dry cloth. If still not completely clear, moisten cloth with one of the following solvents:
 - Isopropyl alcohol
 - Ethyl alcoholSolvents other than those mentioned above may damage the polarizer. Especially, do not use the following:
 - Water
 - Ketone
 - Aromatic solvents
- 10.1.6 Do not attempt to disassemble the LCD Module.
- 10.1.7 If the logic circuit power is off, do not apply the input signals.
- 10.1.8 To prevent destruction of the elements by static electricity, be careful to maintain an optimum work environment.
 - 10.1.8.1 Be sure to ground the body when handling the LCD Modules.
 - 10.1.8.2 Tools required for assembly, such as soldering irons, must be properly ground.
 - 10.1.8.3 To reduce the amount of static electricity generated, do not conduct assembly and other work under dry conditions.
 - 10.1.8.4 The LCD Module is coated with a film to protect the display surface. Be care when peeling off this protective film since static electricity may be generated.

10.2 Storage Precautions

- 10.2.1 When storing the LCD modules, avoid exposure to direct sunlight or to the light of fluorescent lamps.
- 10.2.2 The LCD modules should be stored under the storage temperature range. If the LCD modules will be stored for a long time, the recommend condition is:
Temperature : 0°C ~ 40°C Relatively humidity: ≤80%
- 10.2.3 The LCD modules should be stored in the room without acid, alkali and harmful gas.

10.3 Transportation Precautions

The LCD modules should be no falling and violent shocking during transportation, and also should avoid excessive press, water, damp and sunshine.