

<b>PRODUCT</b> 产品名称	LCD MODULE : 液晶显示模块
<b>MODEL NO.</b> 模块型号	: TFT3P7533-E
<b>SUPPLIER</b> 供应商	TRULY SEMICONDUCTORS LTD. : 信利半导体有限公司
<b>DATE</b> 日期	: Jul 04, 2023

CERT. No. QAC0946535  
(ISO9001)CERT. No. HKG002005  
(ISO14001)

# SPECIFICATION

## 产品说明书

Revision: 0.1

版本: 0.1

**TFT3P7533-E**

This module uses ROHS material  
模块用环保材料

preliminary

If there is no special request from the customer, TRULY SEMICONDUCTORS LTD. will not reserve the tooling of the product under the following conditions:

如有下列情况，但客户又没有特别的要求，信利半导体公司将不储存产品模具：

1. There is no response from the customer in two years after TRULY SEMICONDUCTORS LTD. submit the samples.  
从信利提供样品后，两年内客户如果没回应；
2. There is no order in two years after the latest mass production.  
在最后一批的批量后两年内没有订单。

And correlated data (including quality records) will be reserved for one year more after tooling is discarded.  
相关的数据(包括质量报告)将会被保留一年或更久直到模具放弃。

**TRULY SEMICONDUCTORS LTD.:**

信利半导体有限公司

Quality Assurance Department: \_\_\_\_\_

质量保证部门

Approved by: \_\_\_\_\_

核准

Technical Department: \_\_\_\_\_

技术部门

**CUSTOMER:**

客户：

Approved by: \_\_\_\_\_

核准：

**REVISION RECORD**

修改记录

<b>REV NO.</b> 版本号	<b>REV DATE</b> 修改日期	<b>CONTENTS</b> 内容	<b>REMARKS</b> 注释
0.1	2023-07-04	First release	Preliminary

**CONTENTS 内容****■ GENERAL INFORMATION**

主要特征描述

**■ EXTERNAL DIMENSIONS**

外形尺寸

**■ ABSOLUTE MAXIMUM RATINGS**

极限参数

**■ ELECTRICAL CHARACTERISTICS**

模块电气特性

**■ BACKLIGHT CHARACTERISTICS**

背光电气特性

**■ ELECTRO-OPTICAL CHARACTERISTICS**

光电参数

**■ INTERFACE DESCRIPTION**

接口定义描述

**■ INTERFACE TIMING**

接口时序

**■ REFERENCE APPLICATION CIRCUIT**

参考应用电路

**■ RELIABILITY TEST CONDITIONS**

可靠性试验条件

**■ INSPECTION CRITERION**

检查标准

**■ PRECAUTIONS FOR USING LCD MODULES**

使用注意事项

**■ PACKING SPECIFICATION**

包装规格书

**■ PRIOR CONSULT MATTER**

提前商议事项

**■ FACTORY CONTACT INFORMATION**

工厂联系信息

<b>WRITTEN BY</b> 制作	<b>CHECKED BY</b> 检查	<b>APPROVED BY</b> 核准
LI YU	DU WEI	ZHOU DING

**■ GENERAL INFORMATION****主要特征描述**

<b>Item of general information</b> 项目	<b>Contents</b> 内容	<b>Unit</b> 单位
LCD Type 液晶显示类型	TFT/TRANSMISSIVE/NB	/
Recommended Viewing Direction 模块推荐使用方向	ALL	O' Clock
Module area (W × H×T) 模块外围尺寸 (宽 × 高×厚)	142.48×185.50×8.97	mm <sup>3</sup>
Viewing area (W×H) 可视区域 (宽 × 高)	129.87×172.50	mm <sup>2</sup>
Active area (W×H) 有效区域 (宽 × 高)	127.872×170.496	mm <sup>2</sup>
Number of Dots 点阵	768×1024RGB	/
Pixel pitch (W × H) 像素间隙(宽 × 高)	0.1665×0.1665	mm <sup>2</sup>
Driver IC 驱动集成电路	HX8290*2+HX8695*1	/
Interface Type 接口类型	LVDS interface	/
Input voltage 输入电压	VCC3.3V =3.3V VL=12V	V
Module Power consumption 模块功耗	TBD	mw
Colors 色彩	8 bit mode :16.7M	/
Backlight Type 背光类型	LED	/
Recommended Frame Rate 模块推荐使用帧频	60	Hz

**EXTERNAL DIMENSIONS**  
外形尺寸

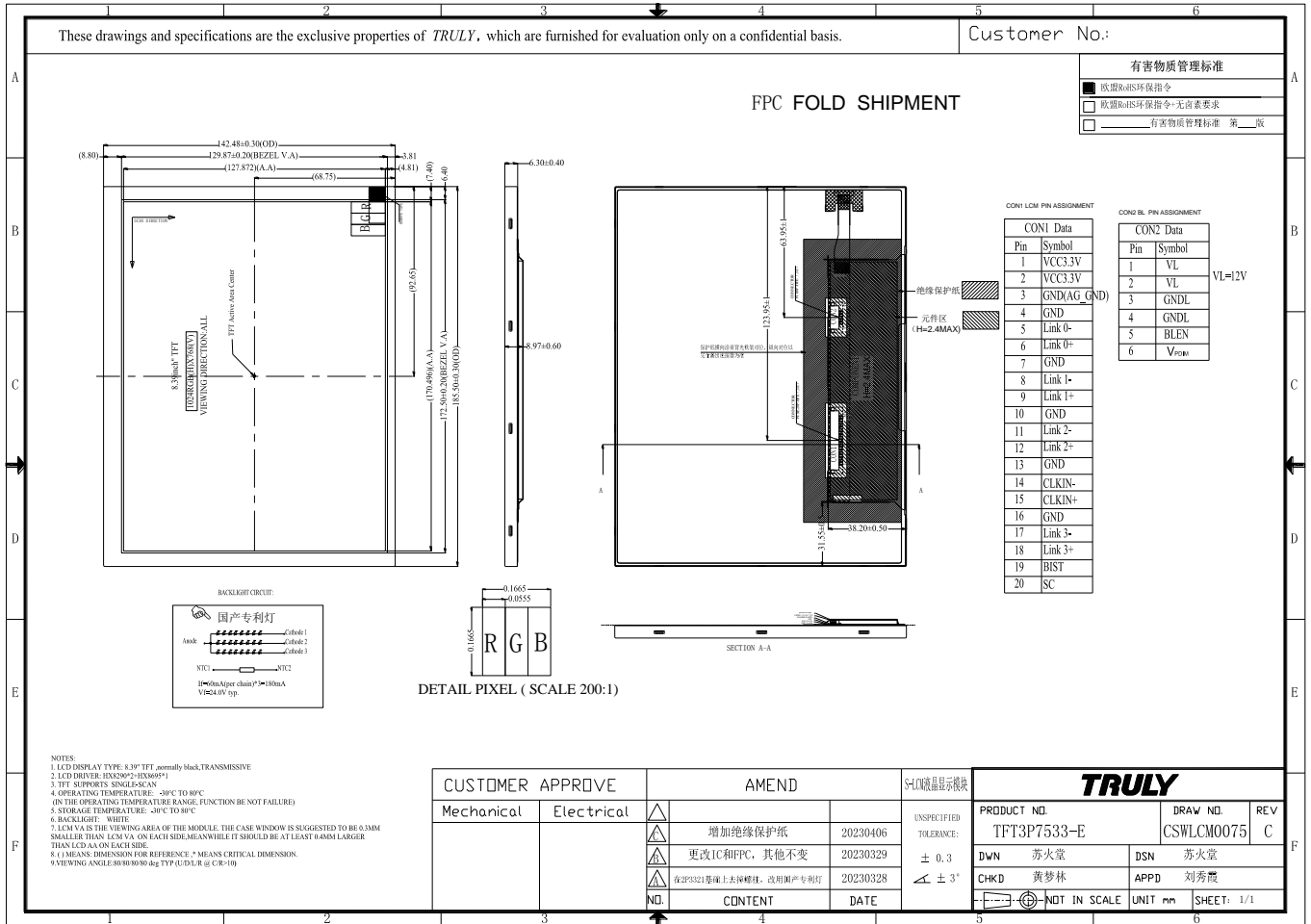

## ■ ABSOLUTE MAXIMUM RATINGS

### 极限参数

Parameter of absolute maximum ratings 参数	Symbol 符号	Min 最小值	Max 最大值	Unit 单位
Supply voltage 供给电压	VCC3.3V	-0.3	4.0	V
BL Supply voltage 背光供给电压	VL	-0.3	28	V
BLEN Input voltage BLEN 输入电压	BLEN	-0.3	28	V
V <sub>PDIM</sub> Input voltage V <sub>PDIM</sub> 输入电压	V <sub>PDIM</sub>	-0.3	28	V
Operating temperature 操作温度	Top	-30	80	°C
Storage temperature 储存温度	TST	-30	80	°C
Humidity 湿度	RH	-	90%(Max60 °C)	RH

Note: Absolute maximum ratings means the product can withstand short-term, NOT more than 120 hours. If the product is a long time to withstand these conditions, the life time would be shorter.

备注: 极限条件仅指产品能短暂承受的范围, 不可超过 120 小时。如果产品长时间在极限条件, 将有损产品的使用寿命。

## ■ ELECTRICAL CHARACTERISTICS

### 模块电气特性

#### DC CHARACTERISTICS

##### 直流特性

Parameter of DC characteristics 参数	Symbol 符号	Min 最小值	Typ 典型值	Max 最大值	Unit 单位
Supply voltage 供给电压	VCC3.3V	3.2	3.3	3.4	V
Input Current 输入电流	Ivdd	-	(76)	(91)	mA

Date for reference in parentheses, 括号内数据仅供参考.

**注意:** 此型号使用的初始化代码和应用电路是基于电压设置为典型值条件下制作, 所以请按以上按电压典型值设置模块工作条件, 否则可能导致模块无法达到最佳显示性能或工作异常。因此若有不同, 请提前和 Truly 确认, 以确保和 Truly 使用的电压设置一致。

Note: The initial code and application circuit used for this module is based on the typical votage value we set. Please set the module working condition as above typical voltage value. If different, the mdoule may not reach the best display performace or display abnormally. So please double check with Truly R&D technicians about the display module driving voltage setting if you use other voltage setting. Ensure the display driving voltage setting is consistent with Truly.

#### Backlight circuit DC CHARACTERISTICS

**背光电路直流特性**

Parameter of DC characteristics 参数	Symbol 符号	Min 最小值	Typ 典型值	Max 最大值	Unit 单位
Supply voltage for BL BL 电压	VL	10.8	12	13.2	V
Input Current(When VL=12V) VL为12V时输入电流	I <sub>VL</sub>	-	TBD	TBD	mA
PWM/EN Logic Low Threshold PWM/EN 低电平电压	V <sub>IL</sub>	0	-	0.4	V
PWM/EN Logic High Threshold PWM/EN 高电平电压	V <sub>IH</sub>	1.8	-	24	V
PWM input frequency 输入频率	f <sub>PWM</sub>	100	-	30,000	Hz
PWM Duty PWM占空比	Duty	5	-	100	%

Date for reference in parentheses,括号内数据仅供参考.

Truly testing condition : Ta=25°C, VL=12V+/-0.2V, Duty=100%

\*The LED driver IC contained in LCM

\*背光驱动 IC 是集成在模组上的,背光驱动电路供电条件见上表

**■ BACKLIGHT CHARACTERISTICS**
**背光电气特性**

Item of backlight characteristics 项目	Symbol	Min.	Typ.	Max.	Unit	Condition
Forward voltage正向电压	Vf	-	24	-	V	If=180mA;Ta=25°C
Number of LED 灯数	-	-	3*8	-	Piece	-
Connection mode 连接类型	P/S	-	Parallel/Serial	-	-	-

Date for reference in parentheses,括号内数据仅供参考

Using condition: constant current driving method If=180mA(+/-10%).

使用条件: 恒流的驱动方式是 If=180mA(+/-10%).

## ■ ELECTRO-OPTICAL CHARACTERISTICS

### 光电参数

Item of electro-optical characteristics 项目	Symbol 符号	Condition 条件	Min 最小值	Typ 典型值	Max 最大值	Unit 单位	Remark 注释	Note 备注
Response time 响应时间	Tr+ Tf	$\theta=0^\circ$ $\varnothing=0^\circ$ Ta=25°C	-	(25)	(40)	ms	FIG 1.	4
Contrast ratio 对比度	Cr		(300)	(800)	-	-	FIG 2.	1
Luminance uniformity 均匀度	$\delta$ WHITE		(70)	(80)	-	%	FIG 2.	3
Surface Luminance 表面亮度	Lv		(400)	(700)	-	cd/m <sup>2</sup>	FIG 2.	2
Viewing angle range 视角范围	$\theta$	$\varnothing = 90^\circ$	70	80	-	deg	FIG 3.	6
		$\varnothing = 270^\circ$	70	80	-	deg	FIG 3	
		$\varnothing = 0^\circ$	70	80	-	deg	FIG 3	
		$\varnothing = 180^\circ$	70	80	-	deg	FIG 3	
NTSC ratio 色彩饱和度	-	-	-	65	-	%	-	-
CIE (x, y) chromaticity CIE 色度坐标	Red x	$\theta=0^\circ$ $\varnothing=0^\circ$ Ta=25°C	-	(0.6208)	-	-	FIG 2.	5
	Red y		-	(0.3312)	-	-		
	Green x		-	(0.3038)	-	-		
	Green y		-	(0.6233)	-	-		
	Blue x		-	(0.1561)	-	-		
	Blue y		-	(0.0569)	-	-		
	White x		-	(0.3056)	-	-		
	White y		-	(0.3267)	-	-		

Date for reference in parentheses,括号内数据仅供参考。

注意：以上光电参数是在 LCD 驱动电压和背光驱动条件在典型值条件下测试，如使用不同的驱动条件测试，请提前和 Truly 确认。  
 Note: The above optical data is based on the typical value we set for display module including LCD and backlight driving. Please check with Truly if you use other driving voltage parameter.

Note1. Contrast Ratio(CR) is defined mathematically by the following formula. For more information see FIG 2.:

$$\text{Contrast Ratio(CR)} = \frac{\text{Average Surface Luminance with all white pixels (P1, P2, \dots)}}{\text{Average Surface Luminance with all black pixels (P1, P2, \dots)}}$$

备注1. 对比度是由以下公式计算所得。详见FIG 2.。

对比度= 显示白色画面时平均表面亮度 (P 1, P2, ……) / 显示黑色画面时平均表面亮度 (P 1, P2, ……)

Note2. Surface luminance is the LCD surface luminance with all white pixels. For more information see FIG 2.

$$L_v = \text{Average Surface Luminance with all white pixels (P1, P2, \dots)}$$

备注2. 表面亮度是在显示白色画面时，测试的亮度值，详见FIG 2.。



$L_v$  =平均的表面亮度 (P1, P2, …… )

Note3. The uniformity in surface luminance ( $\delta$  WHITE) is determined by measuring luminance at each test position, and then dividing the maximum luminance of all white pixels by minimum luminance of all white pixels. For more information see FIG 2.

$$\delta \text{ WHITE} = \frac{\text{Minimum Surface Luminance with all white pixels (P1, P2, ……)}}{\text{Maximum Surface Luminance with all white pixels (P1, P2, …….)}}$$

备注3. 均匀度是在显示白色画面时，测试P1到P9的亮度，然后再用9个点亮度的最小值除以最大值。详见FIG 2.。

均匀度 =白色画面下表面亮度最小值 (P1, P2, …….) /白色画面下表面高度最大值 (P1, P2, …….)

Note4. Response time is the time required for the display to transition from White to black(Rise Time,  $T_r$ ) and from black to white(Decay Time,  $T_f$ ). For additional information see FIG 1..

备注4. 响应时间是  $T_r$  (上升时间) 与 $T_f$ (下降时间)的和;  $T_r$  指显示白色画面转为显示黑色画面需要时间,  $T_f$  指显示黑色画面转为显示白色画面需要时间。详见FIG 1.。

Note5. CIE(x, y) chromaticity is the Center point value. For more information see FIG 2.

备注5. 选择中心点 分别测试x, y值。详见FIG 2.。

Note6. Viewing angle is the angle at which the contrast ratio is greater than a specific value. For TFT module, the specific value of contrast ratio is 10; For monochrome and color stn module, the specific value of contrast ratio is 2.The angles are determined for the horizontal or x axis and the vertical or y axis with respect to the z axis which is normal to the LCD surface. For more information see FIG 3.

备注6. 视角 指对比度大于等于一个特定值时的可视范围, 对TFT屏, 对比度特定值为10, 对黑白屏, CSTN屏, 对比度特定值为2。视角由横轴 (x轴), 竖轴 (y轴) 同Z轴 (垂直于LCD表面) 之间的夹角来定义。详见FIG 3.。

Note7. For Viewing angle and response time testing, the testing data is base on Autronic-Melchers's ConoScope. Series Instruments. For contrast ratio, Surface Luminance, Luminance uniformity and CIE, the testing data is base on CS-2000 photo detector.

备注7. 视角和响应时间, 测试数据基于Autronic-Melchers' s ConoScope. 系列。而对比度, 表面亮度, 均匀度, CIE坐标, 测试数据基于CS-2000 photo detector。

Note8. For TN type TFT transmissive module, Gray scale reverse occurs in the direction of panel viewing angle

备注8. TN型TFT全透产品, 在视角方向会发生灰度反转。

**FIG.1. The definition of Response Time**

响应时间定义

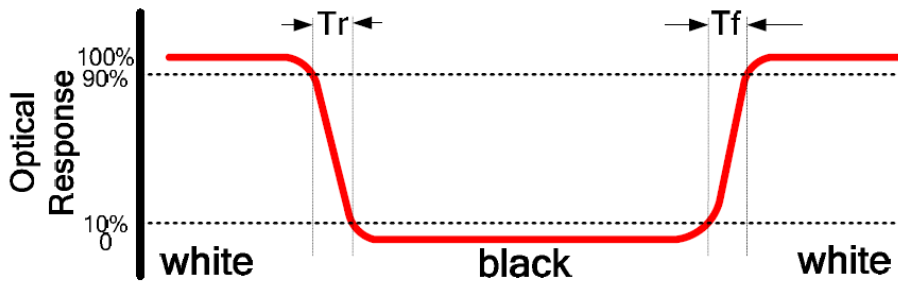

**FIG.2. Measuring method for Contrast ratio, surface luminance, Luminance uniformity, CIE (x, y) chromaticity**

对比度, 表面亮度, 均匀度, CIE坐标测试方法

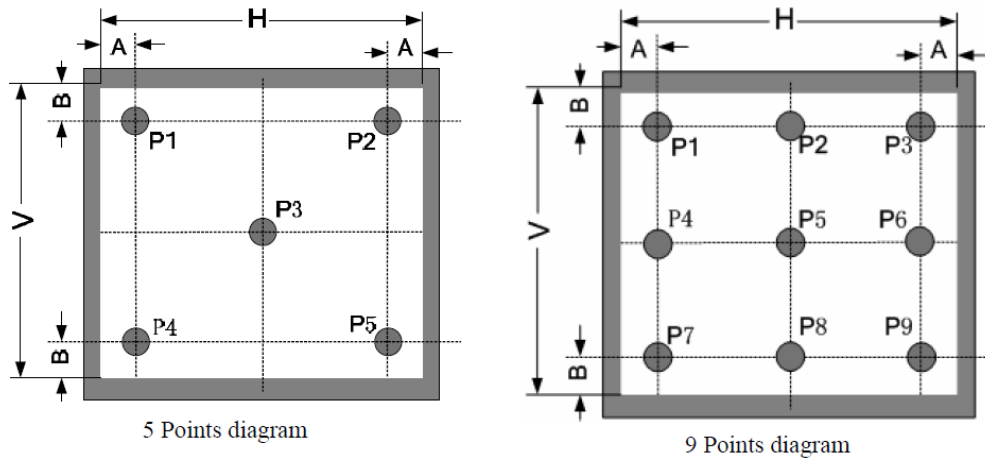

Fig2 Note1 For TFT Module Test point:9 points( as 9 Points diagram )

$A : H/6$   $B : V/6$

$H, V$  : Active Area(AA) size

Measurement instrument: CS-2000; Light spot size  $\varnothing=5\text{mm}$ , 350mm distance from the LCD surface to detector lens.

Fig2 Note2 For non-TFT Module and Dot-Matrix type Module

- 2.1 If the minimum side size is bigger than 20 mm, the testing method is the same as TFT module.
- 2.2 If the minimum side size is less than 20 mm, then testing 5 point datas (as 5 Points diagram), Both  $A$  and  $B$  are 5 mm.
- 2.3 Measurement instrument: CS-2000 is priority selected to measure.  
Light spot size  $\varnothing=5\text{mm}$ , 350mm distance from the LCD surface to detector lens.
- 2.4 Measurement instrument : ConoScope will be selected to measure If CS-2000 cannot meet the measurement requirement.  
Light spot size  $\varnothing=0.2-2.0\text{mm}$ . About 2-3mm distance from the LCD surface to detector lens, but suggest to confirm the best distance on focusing the picture to be clearest when actually measuring.

Fig2 Note3 For non-TFT Module and non-Dot-Matrix type Module

The test point is defined by the fact size and shape of module, but the center point and four edges should be selected.

3.1 Measurement instrument: CS-2000 is priority selected to measure..

Light spot size  $\varnothing=5\text{mm}$ , 350mm distance from the LCD surface to detector lens.

3.2 Measurement instrument : ConoScope will be selected to measure If CS-2000 cannot meet the measurement requirement.

Light spot size  $\varnothing=0.2\text{-}2.0\text{mm}$ . About 2-3mm distance from the LCD surface to detector lens, but suggest to confirm the best distance on focusing the picture to be clearest when actually measuring.

**FIG.3. The definition of viewing angle**

视角定义

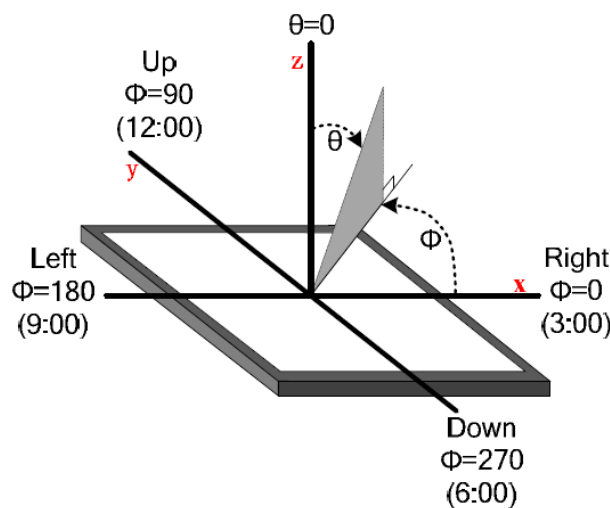

## ■ INTERFACE DESCRIPTION

### 接口定义描述

#### CON1 Interface

Interface NO.接口序号	Symbol 符号	I/O or connect to 输入/出 或 连接到	Description 描述	When not in use 不用时
1	VCC3.3V	Power supply	Power Supply, 3.3V (typical)	-
2	VCC3.3V	Power supply	Power Supply, 3.3V (typical)	-
3	GND(AG_GND)	Ground	Must connect to GND.	-
4	GND	Ground	Ground	-
5	Link0-	I	LVDS DATA 0-	-
6	Link0+	I	LVDS DATA 0+	-
7	GND	Ground	Ground	-
8	Link1-	I	LVDS DATA 1-	-
9	Link1+	I	LVDS DATA 1+	-
10	GND	Ground	Ground	-
11	Link2-	I	LVDS DATA 2-	-
12	Link2+	I	LVDS DATA 2+	-
13	GND	Ground	Ground	-
14	CIKIN-	I	CLOCK IN NEGATIVE FOR LVDS	-
15	CIKIN+	I	CLOCK IN POSITIVE FOR LVDS	-
16	GND	Ground	Ground	-
17	Link3-	I	LVDS DATA 3-	-
18	Link3+	I	LVDS DATA 3+	-
19	BIST	I	Test PIN. No connection, must be open or conncet to GND.	Open/GND
20	SC	I	Scan direction select: SC=LOW, Right to Left, Down to Up; SC=HIGH, Left to Right, Up to Down.	-

#### CON2 Interface

Interface NO.接口序号	Symbol 符号	I/O or connect to 输入/出 或 连接到	Description 描述	When not in use 不用时
1	VL	P	Power Supply for LED driver.	-
2	VL	P	Power Supply for LED driver.	-
3	GNDL	P	Ground	-
4	GNDL	P	Ground	-
5	BLEN	I	LED driver Enable Pin , High active.	-
6	V <sub>PDIM</sub>	i	PWM input pin	-

**INTERFACE TIMING**

接口时序

**Power on sequence:**

A. If VSP and VSN are generated by PFM circuits:

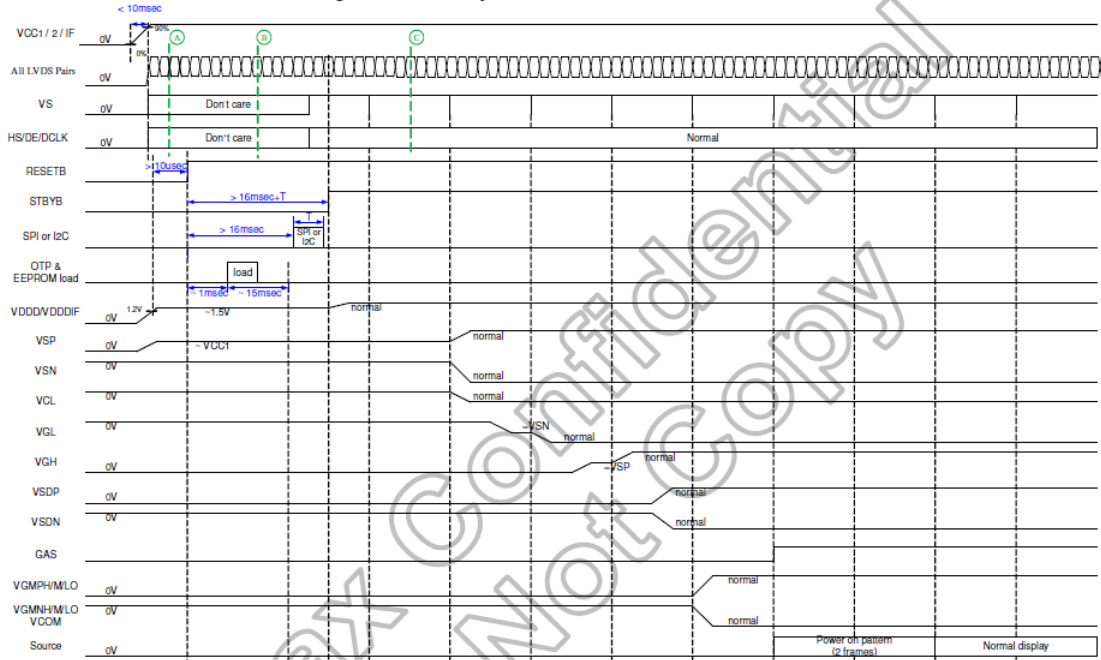

- Note:**
- (1) Registers R01h, R02h, R03h, HSETPASS[3:0], HSETNUM[10:0], GATEPASS[3:0], GATENUM[10:0] in page0 and all registers in page 7 (LVDS settings) should be set before STBYB is pulled to 1.
  - (2) If the application system is not able to completely follow the power on sequence shown above, please contact Himax for suggestions.
  - (3) The valid LVDS signals (clock pair and all data pairs in toggling state) must be consistent with panel resolution and input timing specification.
  - (4) The application system can apply LVDS signals from point A (VCC is ready and not reset completed), B (reset completed and in standby mode), or C (reset completed and non-standby mode).
  - (5) If the system has no need for SPI or I2C command in the power on phase, there is no STBYB input sequence requirement. But STBYB can not come before VCC1.

**Figure 6.1: Power-on sequence with PFM**

**Power off sequence:**

A. If VSP and VSN are generated by PFM circuits:

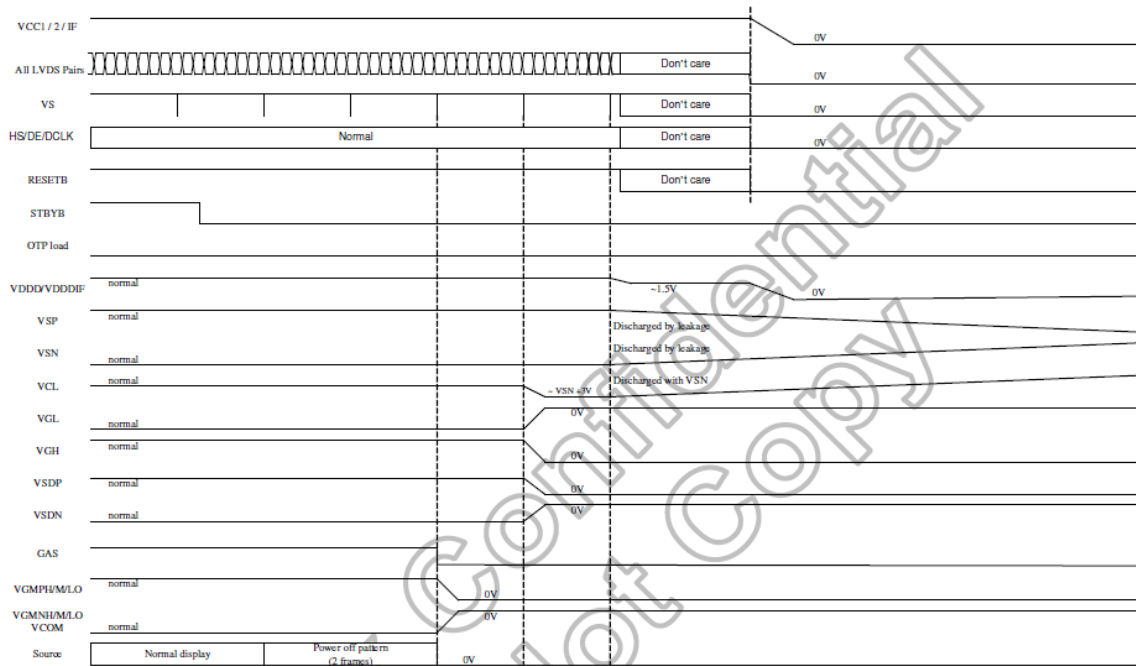

**Figure 6.3: Power-off sequence with PFM**

**PORCH SETTING**

IC SPEC:

Parameter	Symbol	1024xRGBx768 (One Port)		
		Min.	Typ.	Max.
		DCLK frequency	F <sub>DCLK</sub>	49.0
Horizontal valid data	t <sub>hd</sub>	1024		
Hsync pulse Width	t <sub>hpw</sub>	10	12	255
Hsync back porch	t <sub>hbp</sub>	5	16	255
Hsync front porch	t <sub>hfp</sub>	24	26	260
1 Horizontal line	t <sub>h</sub>	1053	1066	1331
Vertical valid data	t <sub>vd</sub>	768		
Vsync pulse width	t <sub>vpw</sub>	1	3	20
Vsync back porch	t <sub>vbp</sub>	2	5	255
Vsync front porch	t <sub>vfp</sub>	5	8	260
1 Vertical field	t <sub>v</sub>	775	781	998
Frame rate	FR	-	60	-

信利软件设定:

Symbol	Value	Unit	Remark
H-Active	1024	Dclk	-
V-Active	768	Line	-
VBPD	2	Line	-
VFPD	9	Line	-
VSPW	3	Line	-
HBPD	4	Dclk	-
HFPD	30	Dclk	-
HSPW	12	Dclk	-
FrameRate	60	Hz	-
DOTCLK	50.2	MHz	Note1

Note: Customer's Porch Settings need to be confirmed according to MCU requirements and display effects. Please consult our technical department for detail information.

注意: 客户主板 Porch 设定要根据主板 MCU 要求及显示效果来确定, 详细信息请联系我们的技术部。

Note1: DOTCLK=FrameRate \* ( H-Active +HBPD+HFPD+HSPW)\*( V-Active +VBPD+VFPD+VSPW)  
7.4

■ REFERENCE APPLICATION CIRCUIT

参考应用电路

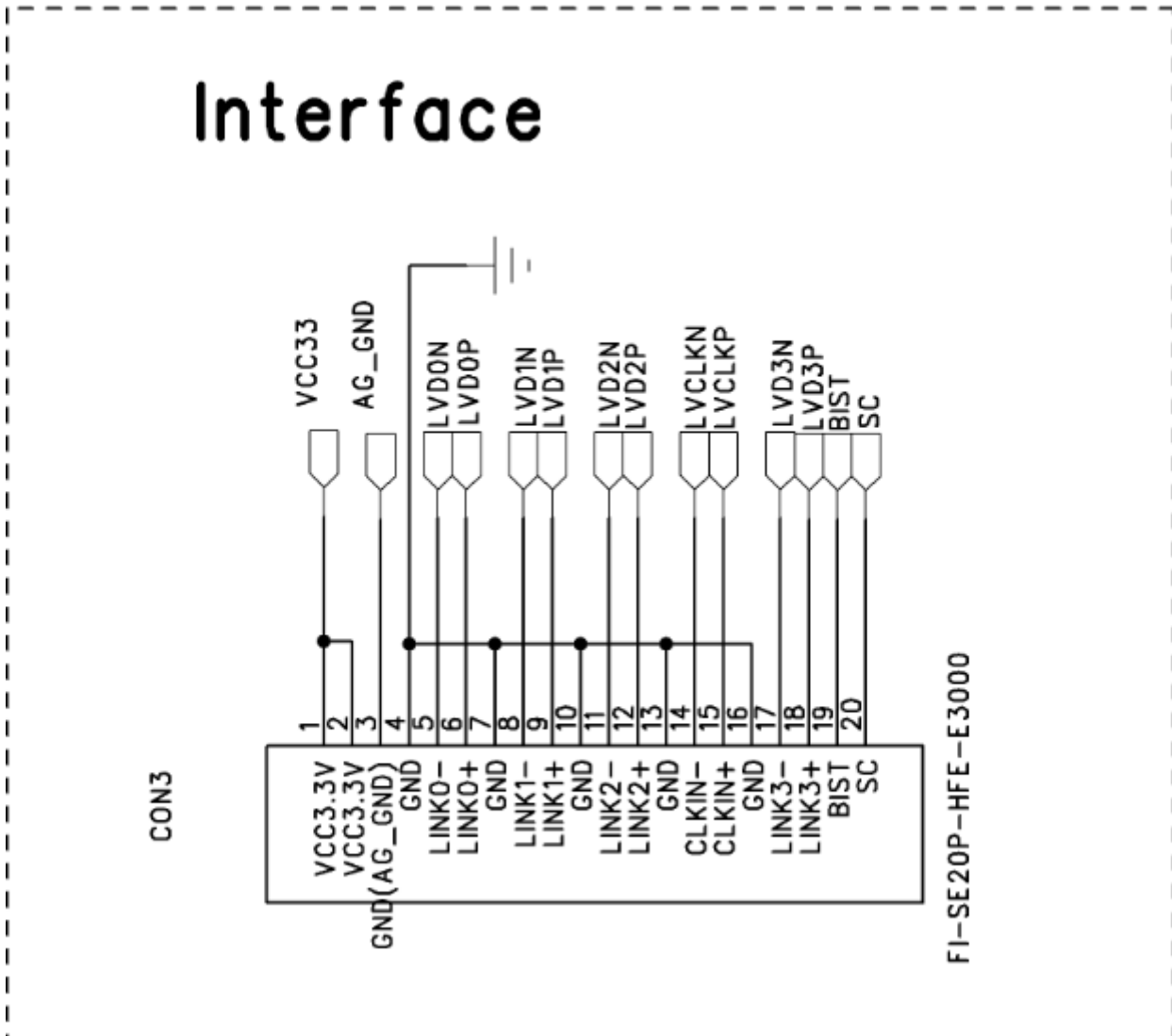

Please consult our technical department for detail information.  
 详细信息请联系我们的技术部



## ■ RELIABILITY TEST CONDITIONS

### 可靠性试验条件

No. 序号	Test Item 试验项目	Test Condition 试验条件	Inspection after test 判断标准
1	High Temperature Storage 高温存放	80±2℃/200 hours	Inspection after 2~4hours storage at room temperature, the sample shall be free from defects: 试验结束后,已测试的 LCD 样品必须在室内正常温湿度环境下放置 2~4 个小时以上才能进行功能和外观检查,样品不允许有以下缺陷: 1.Air bubble in the LCD; 模块中有气泡; 2.Sealleak; 封口松脱; 3.Non-display; 不显示; 4.missing segments; 漏笔 5.Glass crack; 玻璃破碎; 6.Current Idd is twice higher than initial value. 电流 Idd 大于初时值的 2 倍
2	Low Temperature Storage 低温存放	-30±2℃/200 hours	
3	High Temperature Operating 高温操作	80±2℃/120 hours	
4	Low Temperature Operating 低温操作	-30±2℃/120 hours	
5	Temperature Cycle storage 冷热循环存放	-20±2℃~25~60±2℃×10cycles (30min.) (5min.) (30min.)	
6	Damp proof Test operating 防潮试验操作	50℃±5℃×90%RH/120 hours	
7	Vibration Test 振荡试验	Frequency: 10Hz~55Hz~10Hz Amplitude: 1.5mm, X, Y, Z direction for total 3hours (Packing condition)	
8	Dropping test 跌落试验	Drop to the ground from 1m height, one time, every side of carton. (Packing condition)	
9	ESD test 静电试验	Voltage:±8KV R: 330Ω C: 150pF Air discharge, 10time	
Remark: 注意: 1.The test samples should be applied to only one test item. 每个被测试的模块只能用于其中的一个测试项目。 2.Sample size for each test item is 5~10pcs. 每个测试项目的样品数量为 5~10 片。 3.For Damp Proof Test, Pure water(Resistance>10MΩ) should be used. 对于防潮试验, 试验箱的用水必须是电阻大于10M欧姆的纯水。 4.In case of malfunction defect caused by ESD damage, if it would be recovered to normal state after resetting, it would be judged as a good part. 如果由静电引起产品故障,当放置一段时间后能够恢复正常, 则不视为产品缺陷。 5.EL evaluation should be excepted from reliability test with humidity and temperature: Some defects such as black spot/blemish can happen by natural chemical reaction with humidity and Fluorescence EL has. 带EL片的可靠性测试在高温高湿条件下,荧光粉会发生自然化学反应而产生黑点或瑕疵,因此不在高温高湿条件测试范围内。 6.Failure Judgment Criterion: Basic Specification, Electrical Characteristic, Mechanical Characteristic, Optical Characteristic. 故障判断标准:基本规格,电气特性,机械特性,光电特性			

**■ INSPECTION CRITERION**

**检查标准**

<p><b>TRULY</b><sup>®</sup> OUTGOING QUALITY STANDARD</p>	<p>PAGE 1 OF 5; Edition: AF</p>
<p>TITLE: FUNCTIONAL TEST &amp; INSPECTION CRITERIA</p>	<p>TFT-LCD Module product</p>

This specification is made to be used as the standard of acceptance/rejection criteria for TFT-LCD module product

**1. Sample plan**

Sampling plan according to GB/T2828.1-2012/ISO 2859-1: 1999 and ANSI/ASQC Z1.4-1993, normal level 2 and based on:

Major defect: AQL 0.65

Minor defect: AQL 1.5

**2. Inspection condition**

Viewing distance for cosmetic inspection is about 30cm with bare eyes, and under an environment of **600-1500Lux** light intensity, all directions for inspecting the sample should be within 45 ° against perpendicular line. ((Normal temperature 20~25℃ and normal humidity 60±15%RH )

**3. Definition of Inspection Item.**

**3.1 Definition of inspection zone in LCD.**

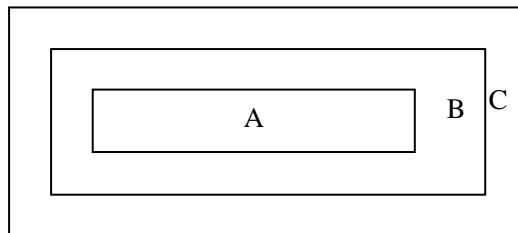

Zone A: character/Digit area

Zone B: viewing area except Zone A (Zone A+Zone B=minimum Viewing area)

Zone C: Outside viewing area (invisible area after assembly in customer’s product)

Fig.1 Inspection zones in an LCD

Note: As a general rule, visual defects in Zone C are permissible, when it is no trouble for quality and assembly of customer’s product.

**3.2 Definition of some visual defect**

<p>Bright dot</p>	<p>Because of losing all or part function, bad pixel dots appear bright and the size is more than 50% of one dot in which LCD panel is displaying under black pattern.</p> 
<p>Dark dot</p>	<p>Dots appear dark and unchanged in size in which LCD panel is displaying under pure red, green, blue picture, or pure whiter picture.</p>

<b>TRULY</b> ® OUTGOING QUALITY STANDARD	PAGE 2 OF 5; Edition: AF
TITLE: FUNCTIONAL TEST & INSPECTION CRITERIA	TFT-LCD Module product

**4. Major Defect**

Item No.	Items to be inspected	Inspection Standard	Classification of defects
4.1	Functional defects	1) No display 2) Display abnormally 3) Missing vertical, horizontal segment 4) Short circuit 5) Excess power consumption 6) Back-light no lighting, flickering and abnormal lighting	major
4.2	Missing	Missing component	
4.3	Outline dimension	Overall outline dimension beyond the drawing is not allowed	

**5. Minor Defect**

Item No.	Items to be inspected	Inspection Standard	Classification of defects																																								
5.1	Bright dot /dark dot defect	<table border="1" style="width:100%"> <thead> <tr> <th rowspan="3" style="width:20%">Zone</th> <th colspan="4" style="text-align:center">Acceptable Qty</th> <th rowspan="3" style="width:5%">C</th> </tr> <tr> <th colspan="4" style="text-align:center">A+B</th> </tr> <tr> <th style="width:15%">LCD≤4.3"</th> <th style="width:15%">4.3"&lt;LCD&lt;7"</th> <th style="width:15%">7"≤LCD≤10.1"</th> <th style="width:15%">LCD&gt;10.1"</th> </tr> </thead> <tbody> <tr> <td>Bright pixel dot</td> <td style="text-align:center">1</td> <td style="text-align:center">1</td> <td style="text-align:center">2</td> <td style="text-align:center">3</td> <td rowspan="5" style="text-align:center">Acceptable</td> </tr> <tr> <td>Dark pixel dot</td> <td style="text-align:center">3</td> <td style="text-align:center">4</td> <td style="text-align:center">4</td> <td style="text-align:center">4</td> </tr> <tr> <td>2 bright dots adjacent</td> <td style="text-align:center">0</td> <td style="text-align:center">0</td> <td style="text-align:center">0</td> <td style="text-align:center">0</td> </tr> <tr> <td>2 dark dots adjacent</td> <td style="text-align:center">0</td> <td style="text-align:center">0</td> <td style="text-align:center">0</td> <td style="text-align:center">0</td> </tr> <tr> <td>Total bright and dark dots</td> <td style="text-align:center">4</td> <td style="text-align:center">5</td> <td style="text-align:center">6</td> <td style="text-align:center">7</td> </tr> </tbody> </table>	Zone	Acceptable Qty				C	A+B				LCD≤4.3"	4.3"<LCD<7"	7"≤LCD≤10.1"	LCD>10.1"	Bright pixel dot	1	1	2	3	Acceptable	Dark pixel dot	3	4	4	4	2 bright dots adjacent	0	0	0	0	2 dark dots adjacent	0	0	0	0	Total bright and dark dots	4	5	6	7	Minor
		Zone		Acceptable Qty					C																																		
				A+B																																							
			LCD≤4.3"	4.3"<LCD<7"	7"≤LCD≤10.1"	LCD>10.1"																																					
		Bright pixel dot	1	1	2	3	Acceptable																																				
		Dark pixel dot	3	4	4	4																																					
		2 bright dots adjacent	0	0	0	0																																					
2 dark dots adjacent	0	0	0	0																																							
Total bright and dark dots	4	5	6	7																																							
<p>Note: Minimum distance between defective dots is more than 5 mm; Pixel dots' function is normal, but bright dots caused by foreign material and other reasons are judged by the dot defect of 5.2.</p>																																											

Item No.	Items to be inspected	Inspection Standard	Classification of defects																																									
5.2	<p>Dot defect</p> <p><math>\Phi = (x+y) / 2</math></p>	<table border="1" style="width:100%"> <thead> <tr> <th rowspan="3" style="width:20%">Zone</th> <th colspan="4" style="text-align:center">Acceptable Qty</th> <th rowspan="3" style="width:5%">C</th> </tr> <tr> <th colspan="4" style="text-align:center">A+B</th> </tr> <tr> <th style="width:15%">LCD≤4.3"</th> <th style="width:15%">4.3"&lt;LCD&lt;7"</th> <th style="width:15%">7"≤LCD≤10.1"</th> <th style="width:15%">LCD&gt;10.1"</th> </tr> </thead> <tbody> <tr> <td>Size (mm)</td> <td>LCD≤4.3"</td> <td>4.3"&lt;LCD&lt;7"</td> <td>7"≤LCD≤10.1"</td> <td>LCD&gt;10.1"</td> <td rowspan="5" style="text-align:center">Acceptable</td> </tr> <tr> <td><math>\Phi \leq 0.15</math></td> <td style="text-align:center">Acceptable</td> <td style="text-align:center">Acceptable</td> <td style="text-align:center">Acceptable</td> <td style="text-align:center">Acceptable</td> </tr> <tr> <td><math>0.15 &lt; \Phi \leq 0.20</math></td> <td rowspan="2" style="text-align:center">3</td> <td rowspan="2" style="text-align:center">4</td> <td rowspan="2" style="text-align:center">5</td> <td rowspan="2" style="text-align:center">6</td> </tr> <tr> <td><math>0.20 &lt; \Phi \leq 0.30</math></td> </tr> <tr> <td><math>0.30 &lt; \Phi \leq 0.50</math></td> <td style="text-align:center">0</td> <td style="text-align:center">0</td> <td style="text-align:center">0</td> <td style="text-align:center">0</td> </tr> <tr> <td><math>\Phi &gt; 0.50</math></td> <td style="text-align:center">0</td> <td style="text-align:center">0</td> <td style="text-align:center">0</td> <td style="text-align:center">0</td> </tr> </tbody> </table>	Zone	Acceptable Qty				C	A+B				LCD≤4.3"	4.3"<LCD<7"	7"≤LCD≤10.1"	LCD>10.1"	Size (mm)	LCD≤4.3"	4.3"<LCD<7"	7"≤LCD≤10.1"	LCD>10.1"	Acceptable	$\Phi \leq 0.15$	Acceptable	Acceptable	Acceptable	Acceptable	$0.15 < \Phi \leq 0.20$	3	4	5	6	$0.20 < \Phi \leq 0.30$	$0.30 < \Phi \leq 0.50$	0	0	0	0	$\Phi > 0.50$	0	0	0	0	Minor
		Zone		Acceptable Qty					C																																			
				A+B																																								
			LCD≤4.3"	4.3"<LCD<7"	7"≤LCD≤10.1"	LCD>10.1"																																						
		Size (mm)	LCD≤4.3"	4.3"<LCD<7"	7"≤LCD≤10.1"	LCD>10.1"	Acceptable																																					
		$\Phi \leq 0.15$	Acceptable	Acceptable	Acceptable	Acceptable																																						
$0.15 < \Phi \leq 0.20$	3	4	5	6																																								
$0.20 < \Phi \leq 0.30$																																												
$0.30 < \Phi \leq 0.50$	0	0	0	0																																								
$\Phi > 0.50$	0	0	0	0																																								
<p>Note: 1. Minimum distance between defective dots is more than 5 mm; 2. The quantity of defect (adjacent dots) is zero in operating condition.</p>																																												

**5. Minor Defect**

Item No.	Items to be inspected	Inspection Standard						Classification of defects	
5.3	Linear defect	Zone		Acceptable Qty				Minor	
		Size (mm)		A+B					
		Length	Width	LCD ≤ 4.3"	4.3" < LCD < 7"	7" ≤ LCD ≤ 10.1"	LCD > 10.1"		C
		Ignore	W ≤ 0.03	Acceptable	Acceptable	Acceptable	Acceptable		Acceptable
		L ≤ 5.0	0.03 < W ≤ 0.10	3	4	5	6		
L > 5.0	W > 0.10	0	0	0	0				
5.4	Polarizer defect	5.4.1 Polarizer Position (i) Shifting in position should not exceed the glass outline dimension. (ii) Incomplete covering of the viewing area due to shifting is not allowed. 5.4.2 Dirt on polarizer Dirt which can be wiped easily should be acceptable. 5.4.3 Polarizer Dent & Air bubble							
		Zone		Acceptable Qty				Minor	
		Size (mm)		A+B					
		Φ ≤ 0.20		LCD ≤ 4.3"	4.3" < LCD < 7"	7" ≤ LCD ≤ 10.1"	LCD > 10.1"		C
		0.20 < Φ ≤ 0.50		Acceptable	Acceptable	Acceptable	Acceptable		Acceptable
Φ > 0.50		3	4	5	6				
		0	0	0	0				
5.4.4 Polarizer scratch (i) If the polarizer scratch can be seen after cover assembling or in the operating condition, judge by the linear defect of 5.3. (ii) If the polarizer scratch can be seen only in non-operating condition or some special angle, judge by the following:									
Zone		Acceptable Qty				Acceptable			
Size (mm)		A+B							
Length	Width	LCD ≤ 4.3"	4.3" < LCD < 7"	7" ≤ LCD ≤ 10.1"	LCD > 10.1"		C		
Ignore	W ≤ 0.03	Acceptable	Acceptable	Acceptable	Acceptable		Acceptable		
1.0 < L ≤ 5.0	0.03 < W ≤ 0.20	3	4	5	6				
L > 5.0	W > 0.20	0	0	0	0				

<b>TRULY</b> <sup>®</sup> OUTGOING QUALITY STANDARD	PAGE 4 OF 5; Edition: AF
---	--------------------------

TITLE: FUNCTIONAL TEST & INSPECTION CRITERIA	TFT-LCD Module product
--	------------------------

**5. Minor Defect**

Item No.	Items to be inspected	Inspection Standard	Classification of defects
5.5	MURA	Using 3% ND filter, it's NG if it can be seen in R,G,B picture.	Minor
	White/Black dot (MURA)	Visible under: ND3%; $D \leq 0.15\text{mm}$ , Acceptable; $0.15\text{mm} < D \leq 0.5\text{mm}$ , $N \leq 4$ ; $D > 0.5\text{mm}$ , Not allowable.	

5.6	Glass defect	(i) Crack Cracks are not allowed.	Minor
-----	--------------	--------------------------------------	-------

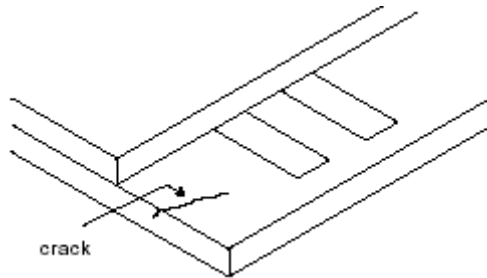

5.6	Glass defect	(ii) TFT chips on corner	Minor
-----	--------------	--------------------------	-------

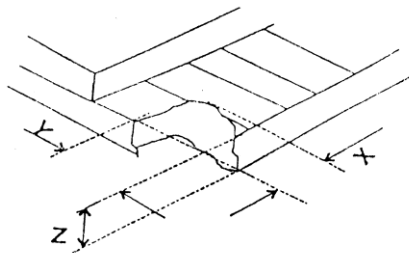

X	Y	Z	Acceptable
$\leq 3.0$	$\leq 3.0$	Not more than the thickness of glass	$N \leq 3$

Chips on the corner of terminal shall not be allowed to extend into the ITO pad or expose perimeter seal.

5.6	Glass defect	(iii) Usual surface crack	Minor
-----	--------------	---------------------------	-------

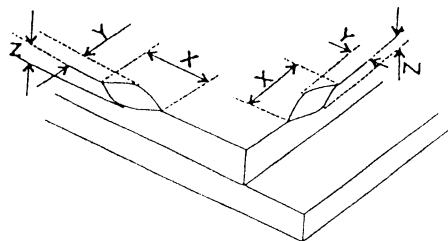

X	Y	Z	Acceptable
$\leq 1.5$	$\leq 1.5$	Not more than the thickness of glass	$N \leq 4$

It is only applicable to the upper glass of LCD.

<b>TRULY</b> <sup>®</sup> OUTGOING QUALITY STANDARD	PAGE 5 OF 5; Edition: AF
TITLE: FUNCTIONAL TEST & INSPECTION CRITERIA	TFT-LCD Module product

**6. Module Cosmetic Criteria**

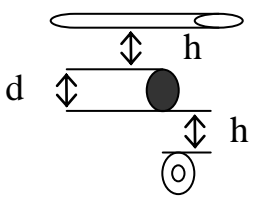
Item No.	Items to be inspected	Inspection Standard	Classification of defects
1	Difference in Spec.	Not allowable	Major
2	Pattern peeling	No substrate pattern peeling and floating	Major
3	Soldering defects	No soldering missing No soldering bridge No cold soldering	Major Major Minor
4	Resist flaw on PCB	Visible copper foil (Ø0.5 mm or more) on substrate pattern is not allowed	Minor
5	FPC gold finger	No dirt, breaking, oxidation lead to black	Major
6	Backlight plastic frame	No deformation, crack, breaking, backlight positioning column breaking, obvious nick.	Minor
7	Marking printing effect	No dark marking, incomplete, deformation lead to unable to judge	Minor
8	Accretion of metallic Foreign matter	No accretion of metallic foreign matter (Not exceed Ø0.2mm)	Minor
9	Stain	No stain to spoil cosmetic badly	Minor
10	Plate discoloring	No plate fading, rusting and discoloring	Minor
11	Solder amount	a. Soldering side of PCB Solder to form a 'Filet' all around the lead. Solder should not hide the lead form perfectly. (too much)	Minor
	1. Lead parts	b. Components side ( In case of 'Through Hole PCB' )  Solder to reach the Components side of PCB.	
	2. Flat packages	Either 'Toe' (A) or 'Seal' (B) of the lead to be covered by 'Filet'. Lead form to be assume over Solder.	Minor
	3. Chips	$(3/2) H \geq h \geq (1/2) H$	Minor
4. Solder ball/Solder splash	a. The spacing between solder ball and the conductor or solder pad $h \geq 0.13$ mm. The diameter of solder ball $d \leq 0.15$ mm.		Minor
	b. The quantity of solder balls or solder splashes isn't beyond 5 in 600 mm <sup>2</sup> .		Minor
	c. Solder balls/Solder splashes do not violate minimum electrical clearance.		Major
	d. Solder balls/Solder splashes must be entrapped / encapsulated or attached to the metal surface .		Minor
Note: Entrapped/encapsulated/attached is intended to mean that normal service environment of the product will not cause a solder ball to become dislodged.			

这份规格书用来作为 **TFT-LCD 模组产品**接收/拒绝的标准。

**1. 抽样计划**

按照抽样方案 GB/T2828.1-2012/ISO 2859-1: 1999 和 ANSI/ASQC Z1.4-1993 Level II 划分样品可以接受或拒绝的等级如下:

重缺陷: AQL 0.65

轻缺陷: AQL 1.5

**2. 检查条件**

检查样品时, 外观检查的观察距离距检查者眼睛 30cm, 在 **600-1500Lux** 日光灯的光照环境下, 保持任何方向检查样品应在垂直方向 45 度以内. (正常温度和湿度分别为 20~25℃, 60±15%RH)。

**3. 检查内容定义**

**3.1 LCD 检查区域定义:**

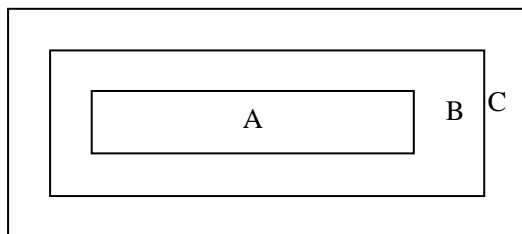

区域 A: 符号或数字显示区域

区域 B: 视区 (除 A 区) (A 区+B 区=最小视区, 相对于模块确认的 VA 区范围)

区域 C: 视区外围 (模块确认图的 VA 区外, 客户机装机后看不到此区域)

如上图: LCD 的检查区域定义

注意: 在区域 C 中看得见的缺陷, 但不影响产品质量以及客户产品的组装, 允许出货。

**3.2 LCD 部分可视缺陷定义**

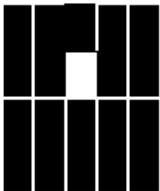
<p>亮点</p>	<p>因像素点部分或全部功能丧失导致黑色画面出现亮度很高并大于50%dot的象素坏死点。</p> 
<p>暗点</p>	<p>当TFT显示全红, 全绿和全蓝的画面时, 亚像素点在屏幕中看起来很暗, 不会发光。</p>

<b>TRULY</b> ® 出货质量对外检查标准	第 2 页, 共 5 页; 版本: AF
项目: 功能测试&检查标准	TFT-LCD 模组产品

**4. 重缺陷**

项目	检查项目	检查标准	缺陷分类
4.1	功能缺陷	1) 不显示 2) 显示异常 3) 缺划 4) 短路 5) 大电流 6) 背光不亮, 闪烁或亮度异常	重
4.2	残缺	缺少元器件	
4.3	外观尺寸	不允许外观尺寸大于图纸尺寸	

**5. 轻缺陷**

项目	检查项目	检查标准					缺陷分类	
		区域	可接收数目					
A+B				C	接收	轻		
LCD ≤ 4.3"	4.3" < LCD < 7"	7" ≤ LCD ≤ 10.1"	LCD > 10.1"					
5.1	亮点/暗点缺陷	亮子像素点	1	1			2	3
		暗子像素点	3	4			4	4
		两个相邻的亮子像素点	0	0			0	0
		两个相邻的暗子像素点	0	0			0	0
		像素点总数目	4	5			6	7
		备注: 像素点缺陷距离必须大于 5 mm; 像素点功能正常, 而由异物等原因引起的发亮的点缺陷按照 5.2 点缺陷判定。						

项目	检查项目	检查标准					缺陷分类	
		区域	可接收数目					
A+B				C	接收	轻		
LCD ≤ 4.3"	4.3" < LCD < 7"	7" ≤ LCD ≤ 10.1"	LCD > 10.1"					
5.2	<p>点缺陷</p> <p><math>\Phi = (x+y)/2</math></p>	尺寸 (mm)	LCD ≤ 4.3"	4.3" < LCD < 7"			7" ≤ LCD ≤ 10.1"	LCD > 10.1"
		Φ ≤ 0.15	接收	接收			接收	接收
		0.15 < Φ ≤ 0.20	3	4			5	6
		0.20 < Φ ≤ 0.30						
		0.30 < Φ ≤ 0.50	0	0	0	0		
Φ > 0.50	0	0	0	0				
备注: 1、两缺陷点之间的距离必须大于 5 mm; 2、点亮时, 相邻点缺陷数量要求 N ≤ 0.								



<b>TRULY®</b> 出货质量对外检查标准	第 3 页, 共 5 页; 版本: AF
项目: 功能测试&检查标准	TFT-LCD 模组产品

5. 轻缺陷

项目	检查项目	检查标准						缺陷分类	
5.3	线缺陷	区域		可接收数目				轻	
		尺寸 (mm)		A+B					
		长度	宽度	LCD ≤ 4.3"	4.3" < LCD < 7"	7" ≤ LCD ≤ 10.1"	LCD > 10.1"		C
		忽略	W ≤ 0.03	接收	接收	接收	接收		接收
		L ≤ 5.0	0.03 < W ≤ 0.10	3	4	5	6		
L > 5.0	W > 0.10	0	0	0	0				
5.4	偏光片缺陷	5.4.1 偏光片位置 (i) 移动的位置不允许超过玻璃的外围尺寸; (ii) 由于偏光片位置移动导致可视区域不能完全可视, 则不接收。 5.4.2 偏光片上的异物 异物容易被擦拭掉, 则接收。 5.4.3 偏光片凹点, 气泡缺陷							
		区域		可接收数目				轻	
		尺寸 (mm)		A+B					
				LCD ≤ 4.3"	4.3" < LCD < 7"	7" ≤ LCD ≤ 10.1"	LCD > 10.1"		C
		Φ ≤ 0.20		接收	接收	接收	接收		接收
0.20 < Φ ≤ 0.50		3	4	5	6				
Φ > 0.50		0	0	0	0				
5.4.4 偏光片划痕 (i) 如果偏光片划痕在组装后或操作运行条件下能够看见, 则按照 5.3 线缺陷进行判定; (ii) 如果偏光片划痕仅在不操作运行条件下或者特殊角落才能看见, 则按如下标准进行判定:									
区域		可接收数目				轻			
尺寸 (mm)		A+B							
长度	宽度	LCD ≤ 4.3"	4.3" < LCD < 7"	7" ≤ LCD ≤ 10.1"	LCD > 10.1"		C		
忽略	W ≤ 0.03	接收	接收	接收	接收		接收		
1.0 < L ≤ 5.0	0.03 < W ≤ 0.20	3	4	5	6				
L > 5.0	W > 0.20	0	0	0	0				

<p><b>TRULY</b><sup>®</sup> 出货质量对外检查标准</p>	<p>第 4 页, 共 5 页; 版本: AF</p>
<p>项目: 功能测试&amp;检查标准</p>	<p>TFT-LCD 模组产品</p>

5. 轻缺陷

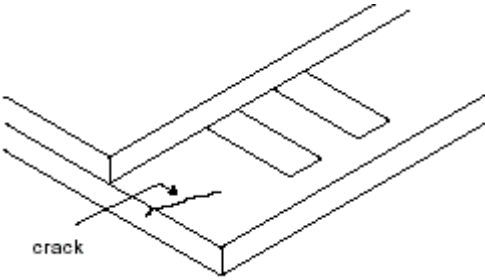
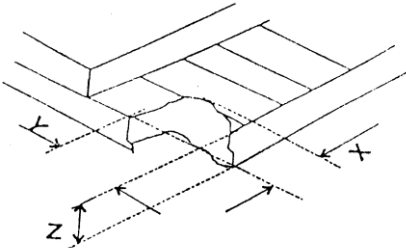
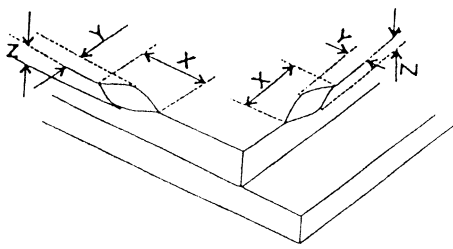
项目	检查项目	检查标准	缺陷分类								
5.5	MURA	使用 3% 的 ND Filter, 在 R,G,B 画面下判定, 能够看见为 NG	轻								
	点黑/点白 (MURA)	Visible under: ND3%; $D \leq 0.15\text{mm}$ , 忽略; $0.15\text{mm} < D \leq 0.5\text{mm}$ , $N \leq 4$ ; $D > 0.5\text{mm}$ , 不允许.									
5.6	玻璃缺陷	<p>(i) 裂缝 裂缝不允许.</p> 	轻								
		<p>(ii) TFT 边角碎裂</p>  <table border="1" data-bbox="450 1355 1141 1456"> <thead> <tr> <th>X</th> <th>Y</th> <th>Z</th> <th>接收</th> </tr> </thead> <tbody> <tr> <td><math>\leq 3.0</math></td> <td><math>\leq 3.0</math></td> <td>不能超过玻璃的厚度</td> <td><math>N \leq 3</math></td> </tr> </tbody> </table> <p>边角碎裂不允许延伸到 ITO 引线或者触及环氧胶, 使环氧胶暴露。</p>	X	Y	Z	接收	$\leq 3.0$	$\leq 3.0$	不能超过玻璃的厚度	$N \leq 3$	轻
		X	Y	Z	接收						
$\leq 3.0$	$\leq 3.0$	不能超过玻璃的厚度	$N \leq 3$								
<p>(iii) 表面碎裂</p>  <table border="1" data-bbox="454 1863 1133 1964"> <thead> <tr> <th>X</th> <th>Y</th> <th>Z</th> <th>接收</th> </tr> </thead> <tbody> <tr> <td><math>\leq 1.5</math></td> <td><math>\leq 1.5</math></td> <td>不能超过玻璃的厚度</td> <td><math>N \leq 4</math></td> </tr> </tbody> </table> <p>此仅适用 LCD 的表面不良。</p>	X	Y	Z	接收	$\leq 1.5$	$\leq 1.5$	不能超过玻璃的厚度	$N \leq 4$	轻		
X	Y	Z	接收								
$\leq 1.5$	$\leq 1.5$	不能超过玻璃的厚度	$N \leq 4$								

<p><b>TRULY</b><sup>®</sup> 出货质量对外检查标准</p>	<p>第 5 页, 共 5 页; 版本: AF</p>
<p>项目: 功能测试&amp;检查标准</p>	<p>TFT-LCD 模组产品</p>

**6. 模块外观标准**

项目	检查项目	检查标准	缺陷分类
1	与规格书不符.	绝不允许	重
2	图案脱落	不允许底层图案脱落或者不固定	重
3	焊接不合格	不能出现虚焊, 漏焊; 不能出现焊接短路; 不能出现冷焊。	重 重 轻
4	PCB 板瑕疵	底板图案上有可见的铜箔 ( $\varnothing \leq 0.5\text{mm}$ )	轻
5	FPC 金手指	不允许出现污染、折断及氧化发黑现象	重
6	背光胶框	不能有变形、裂痕、折断, 定位柱断及明显划痕	轻
7	印字唛效果	不允许字符模糊、残缺、变形造成无法确认	轻
8	过多金属杂质	没有过多金属杂质 ( $\varnothing \leq 0.2\text{mm}$ )	轻
9	污点	没有严重影响外观的污点	轻
10	金属底板褪色	金属底板没有褪色、生锈	轻
11	焊接数量	a. PCB 焊接面在引脚周围焊接形成片状, 在引脚上不能焊接太多。	轻
	1. 引脚部件	b. 元件面 (避免“穿过 PCB 板的孔”) 焊接需接触到 PCB 元件面。.	轻
	2. 引脚封装	趾部 A 到跟部 B 要求有润焊。 焊接后须能看出引脚。	轻
	3. 芯片焊接	$(3/2) H \geq h \geq (1/2) H$	轻
4. 焊锡球/泼溅	a. 固定的焊锡球距焊盘或导线距离 $h \geq 0.13\text{mm}$ , 直径 $d \leq 0.15\text{mm}$ 。		轻
	b. 在 600 平方毫米不允许超过 5 个焊锡球/泼溅		轻
	c. 焊锡球/泼溅不允许违反最小电气间隙。⊙		重
	d. 焊锡球/泼溅必须被包封或附着于金属表面。		轻
		备注: 固定的/附着的或类似的表达, 指在通常使用环境下不会导致松动。	

## ■ PRECAUTIONS FOR USING LCD MODULES

### 使用注意事项

#### 1 Handling Precautions

##### 处理注意事项

- 1.1 The display panel is made of glass and polarizer. As glass is fragile. It tends to become or chipped during handling especially on the edges. Please avoid dropping or jarring. Do not subject it to a mechanical shock by dropping it or impact.

显示屏由玻璃和偏光片组成。由于玻璃是脆的，使用过程中要特别注意边缘区。请防止跌落或振动。不能机械碰撞。

- 1.2 If the display panel is damaged and the liquid crystal substance leaks out, be sure not to get any in your mouth. If the substance contacts your skin or clothes, wash it off using soap and water.

如果显示屏损坏且液晶物质泄漏，切勿入口。如果液晶物质与皮肤或衣服接触，请使用肥皂和水冲洗。

- 1.3 Do not apply excessive force to the display surface or the adjoining areas since this may cause the color tone to vary. Do not touch the display with bare hands. This will stain the display area and degraded insulation between terminals (some cosmetics are determined to the polarizer).

请勿施加过大的压力于显示屏或连接部位，否则会引起色调变化。不要用手接触显示屏，这将弄脏显示区和降低端子之间的绝缘能力（一些外观是由偏光片决定的）。

- 1.4 The polarizer covering the display surface of the LCD module is soft and easily scratched. Handle this polarizer carefully. Do not touch, push or rub the exposed polarizers with anything harder than an HB pencil lead (glass, tweezers, etc.). Do not put or attach anything on the display area to avoid leaving marks on it. Condensation on the surface and contact with terminals due to cold will damage, stain or dirty the polarizer. After products are tested at low temperature they must be warmed up in a container before coming in to contact with room temperature air.

覆盖液晶显示模块显示平面的偏光片是软性且易被擦伤，请小心轻拿。请勿用任何硬度大于 HB 铅笔芯的物品（玻璃，镊子等）接触、撞压或摩擦裸露偏光片。不要放置或粘附物体在显示区域上以免留下痕迹。冷凝在表面和端子将会损坏或弄脏偏光片。产品在低温下测试之后，与室温空气接触之前必须在容器内升温。

- 1.5 If the display surface becomes contaminated, breathe on the surface and gently wipe it with a soft dry cloth. If it is heavily contaminated, moisten cloth with one of the following solvents

- Isopropyl alcohol
- Ethyl alcohol

Do not scrub hard to avoid damaging the display surface.

如果显示平面受污，可对平面吹热气且轻轻地用软性干布擦除。如果受污严重，用含下列一种溶剂的湿布擦除：

- 甘油
- 酒精

请勿用力擦拭以免损坏显示平面。

- 1.6 Solvents other than those above-mentioned may damage the polarizer. Especially, do not use the following.

- Water
- Ketone
- Aromatic solvents

Wipe off saliva or water drops immediately, contact with water over a long period of time may cause deformation or color fading. Avoid contact with oil and fats.

除以上提到的溶剂外，其他溶剂可能会损坏偏光片，特别要避免使用以下溶剂：

- 水
- 酮

-芳烃溶剂

立即擦掉唾液或水滴，长时间与水接触会引起变形或褪色。避免接触油和油脂。

- 1.7 Exercise care to minimize corrosion of the electrode. Corrosion of the electrodes is accelerated by water droplets, moisture condensation or a current flow in a high-humidity environment.

特别注意最小限度地减少电极腐蚀，电极腐蚀会因水滴、湿度冷凝或在高湿环境下通电而加速。

- 1.8 Install the LCD Module by using the mounting holes. When mounting the LCD module make sure it is free of twisting, warping and distortion. In particular, do not forcibly pull or bend the I/O cable or the backlight cable.

使用安装孔装配液晶显示模块，安装时一定不要弯曲、扭曲和变形。要特别注意不要用力拔，弯曲传输线或背光线。

- 1.9 Do not attempt to disassemble or process the LCD module.

请勿拆卸液晶显示模块。

- 1.10 NC terminal should be open. Do not connect anything.

悬空端应断开，不要连接任何器件。

- 1.11 If the logic circuit power is off, do not apply the input signals.

如果逻辑电路电源是断开的，不要施加输入信号。

- 1.12 Electro-Static Discharge Control, Since this module uses a CMOS LSI, the same careful attention should be paid to electrostatic discharge as for an ordinary CMOS IC. To prevent destruction of the elements by static electricity, be careful to maintain an optimum work environment.

由于液晶显示模块使用 CMOS 集成，要特别注意静电放电问题。对 CMOS 器件，要特别注意静电。为防止静电损坏，注意保持合宜的工作环境。

- Before removing LCM from its packing case or incorporating it into a set, be sure the module and your body have the same electric potential. Be sure to ground the body when handling the LCD modules.

-液晶显示模块移出包装盒和安装之前，要保证模块和人体具有相同的电位。处理模块时，可靠接地。

- Tools required for assembling, such as soldering irons, must be properly grounded. Make certain the AC power source for the soldering iron does not leak. When using an electric screwdriver to attach LCM, the screwdriver should be of ground potentiality to minimize as much as possible any transmission of electromagnetic waves produced sparks coming from the commutator of the motor.

- 使用工具如电烙铁，要可靠接地，并确保烙铁使用交流电，不要漏电。用电批固定模块时，电批应接地，尽可能降低电动换向器火花产生的电磁波。

- To reduce the amount of static electricity generated, do not conduct assembling and other work under dry conditions. To reduce the generation of static electricity be careful that the air in the work is not too dry. A relative humidity of 50%-60% is recommended. As far as possible make the electric potential of your work clothes and that of the work bench the ground potential.

- 为减少静电产生，不在干燥组装或其它操作。为降低静电，工作场地一定不要干燥。建议相对湿度为 50%-60%。尽可能使你的工作服和工作台接地。

- The LCD module is coated with a film to protect the display surface. Exercise care when peeling off this protective film since static electricity may be generated.

- 液晶显示模块表面有一个保护膜。需要小心操作以减少撕保护膜时静电的产生。

- 1.13 Since LCM has been assembled and adjusted with a high degree of precision, avoid applying excessive shocks to the module or making any alterations or modifications to it.

由于液晶显示模块由高精度装配和调节制成，应避免对模块过大的冲击或做任何更改。

- Do not alter, modify or change the shape of the tab on the metal frame.
- 不要改动金属架上的翼片形状。
- Do not make extra holes on the printed circuit board, modify its shape or change the positions of components to be attached.
- 不要在印制电路板上钻额外的孔，修改形状或更改印制线路板上元件的位置。
- Do not damage or modify the pattern writing on the printed circuit board.
- 不要更改或损坏印制线路板上的图案。
- Absolutely do not modify the zebra rubber strip (conductive rubber) or heat seal connector.
- 绝对不要更改斑马条（导电胶条）或导电纸连接器。
- Except for soldering the interface, do not make any alterations or modifications with a soldering iron.
- 除焊接接口外，不要用烙铁做任何更改。
- Do not drop, bend or twist the LCM.
- 不要扔、弯和扭模块。

**2 Handling precaution for LCM 模块操作规范**

**2.1 LCM is easy to be damaged. Please note below and be careful for handling.**

液晶显示模块很容易被损坏。请注意以下并小心操作

**2.2 Correct handling: 正确操作:**



As above picture, please handle with anti-static gloves around LCM edges.  
像上面的图片,请戴抗静电手套,并拿模块边缘.

**2.3 Incorrect handling: 错误操作:**



Please don't touch IC directly.  
不要直接地触摸 IC

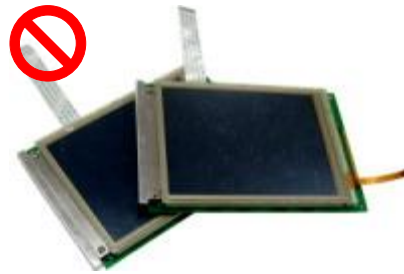

Please don't stack LCM.  
不要把模块叠在一起



Please don't hold the surface of panel.  
请不要拿着面板的表面

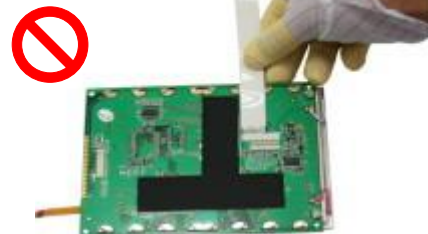

Please don't stretch interface of output, such as FPC cable.  
请不要拉扯输出接口, 如接口线



Please don't hold the surface of IC.  
请不要拿着 IC 的表面

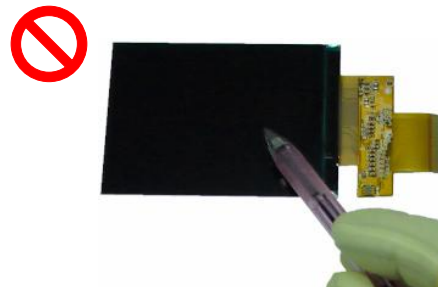

Please don't operate with sharp stick such as pens.  
请不要用尖锐的物体来操作, 例如用笔尖

### 3 Storage Precautions 储存注意事项

3.1 When storing the LCD modules, the following precaution are necessary.

液晶显示模块的存储依照以下几点:

3.1.1 Store them in a sealed polyethylene bag. If properly sealed, there is no need for the desiccant.

使用聚乙烯袋密封, 如果密封得当, 不需要干燥剂。

3.1.2 Store them in a dark place. Do not expose to sunlight or fluorescent light, keep the temperature between 0°C and 35°C, and keep the relative humidity between 40%RH and 60%RH.

避光保存, 避免直接暴露在太阳光或黄光灯下, 保持温度在0~35摄氏度之间, 保持相对湿度在40%RH 和 60%RH之间。

3.1.3 The polarizer surface should not come in contact with any other objects (We advise you to store them in the anti-static electricity container in which they were shipped).

偏光片表面避免接触其他物质 (建议存放在货运防静电包装中)。

3.2 Transportation Precautions 运输注意事项

3.2.1 During shipment, please handle with care. The packaging bag can not be broken, step on trap. Packaging Carton layer height can not be over two meters. 装运过程要轻拿轻放. 不能出现包装袋破损, 踢陷. 卡通箱叠层高度不能超过2米.

3.2.2 The transportation process should pay attention to the waterproof and moisture-proof measures. Product can not be watering. Ethylene sealed bags can not be unsealed. 运输过程要注意有防水和防潮措施. 产品不能淋水. 产品乙烯密封袋不可开封.

3.3 Others 其它

3.3.1 Liquid crystals solidify under low temperature (below the storage temperature range) leading to defective orientation or the generation of air bubbles (black or white). Air bubbles may also be generated if the module is subject to a low temperature.

液晶在低温会凝固 (低于储存温度范围以下), 会导致缺陷或产生气泡 (黑或白)。如果模块处于低温下, 也会产生气泡。

3.3.2 If the LCD modules have been operating for a long time showing the same display patterns, the display patterns may remain on the screen as ghost images and a slight contrast irregularity may also appear. A normal operating status can be regained by suspending use for some time. It should be noted that this phenomenon does not adversely affect performance reliability.

如果液晶显示模块长时间工作于同一个显示图案, 换屏时会出现鬼影, 也会出现轻微的对比度不均。停止使用一段时间后可恢复到正常状态。此现象不会严重影响性能可靠性。

3.3.3 To minimize the performance degradation of the LCD modules resulting from destruction caused by static electricity etc., exercise care to avoid holding the following sections when handling the modules.

工作为最小限度地降低由静电等导致液晶显示模块性能降低, 使用模块时慎重使用下列区域:

3.3.3.1 - Exposed area of the printed circuit board.

- 印制电路板裸露区域。

3.3.3.2 - Terminal electrode sections.

- 印制电路板引出端子区域。



**4 USING LCD MODULES 使用液晶显示模块**

**4.1 Installing LCD Modules 安装液晶显示模块**

The hole in the printed circuit board is used to fix LCM as shown in the picture below. Attend to the following items when installing the LCM.

印制线路板上的孔用来固定液晶显示屏，如下图所示。安装液晶显示模块时，注意以下事项：

- 4.1.1 Cover the surface with a transparent protective plate to protect the polarizer and LC cell.  
贴一层透明保护膜来保护偏光片和液晶盒。

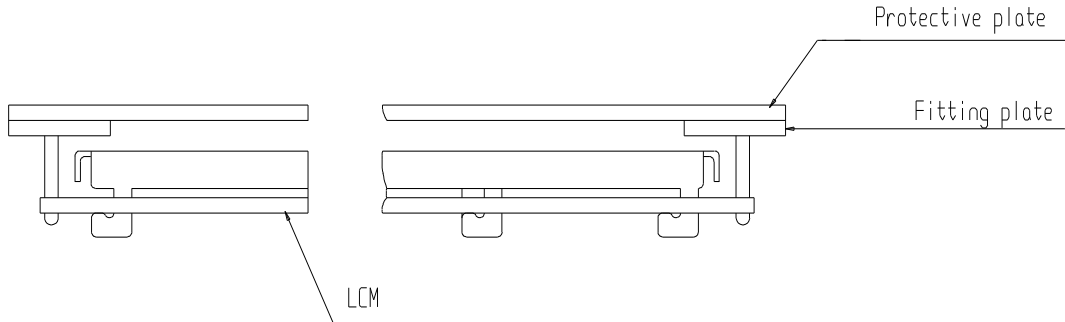

- 4.1.2 When assembling the LCM into other equipment, the spacer to the bit between the LCM and the fitting plate should have enough height to avoid causing stress to the module surface, refer to the individual specifications for measurements. The measurement tolerance should be  $\pm 0.1\text{mm}$ .

将模块安装进入其它设备时，模块和安装板之间间隔应有足够的高度以避免模块表面受压。参照专业度量技术标准。量度公差应是 $\pm 0.1$ 毫米。

**4.2 Precaution for assemble the module with BTB connector:**

用板对板连接器安装液晶显示模块注意事项：

Please note the position of the male and female connector position, don't assemble or assemble like the method which the following picture shows

请注意连接器的公母及连接位置，请勿出现下图所示的连接方式。

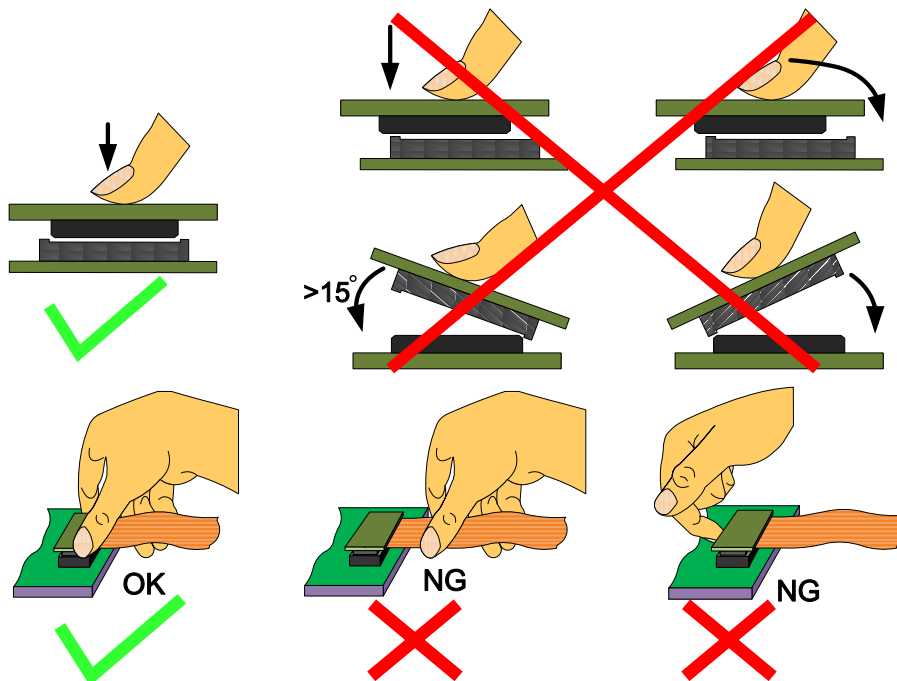

4.3 Precaution for soldering the LCM 焊接模块注意事项

	Manual soldering 手工焊接	Machine drag soldering 机器拖焊	Machine press soldering 机器压焊
No RoHS Product 非环保产品	290°C ~350°C. Time : 3-5S.	330°C ~350°C. Speed : 4-8 mm/s.	300°C ~330°C. Time : 3-6S. Press: 0.8~1.2Mpa
RoHS Product 环保产品	340°C ~370°C. Time : 3-5S.	350°C ~370°C. Time : 4-8 mm/s.	330°C ~360°C. Time : 3-6S. Press: 0.8~1.2Mpa

4.3.1 If soldering flux is used, be sure to remove any remaining flux after finishing to soldering operation (This does not apply in the case of a non-halogen type of flux). It is recommended that you protect the LCD surface with a cover during soldering to prevent any damage due to flux spatters.

如果使用助焊剂，完成焊接后一定要清除剩余的助焊剂（除非卤化物助焊剂）。建议焊接时用盖子保护显示屏面以避免因焊剂油溅出造成的任何损坏。

4.3.2 When soldering the electroluminescent panel and PC board, the panel and board should not be detached more than three times. This maximum number is determined by the temperature and time conditions mentioned above, though there may be some variance depending on the temperature of the soldering iron.

焊接背光源和线路板时，不应装卸多于三次。尽管焊接温度会有变化，但不应超过上面提到的焊接温度和时间最大值。

4.3.3 When remove the electroluminescent panel from the PC board, be sure the solder has completely melted, the soldered pad on the PC board could be damaged.

从线路板上移除背光源时，要保证焊锡已完全熔化，不要损坏线路板上的焊接位。

4.4 Precautions for Operation 工作运行注意事项:

4.4.1 Viewing angle varies with the change of liquid crystal driving voltage (VLCD). Adjust VLCD to show the best contrast.

视角应随液晶驱动电压 (VLCD) 变化而变化. 调整VLCD 可显示最好的对比度。

4.4.2 It is an indispensable condition to drive LCD's within the specified voltage limit since the higher voltage then the limit cause the shorter LCD life. An electrochemical reaction due to direct current causes LCD's undesirable deterioration, so that the use of direct current drive should be avoided.

在液晶驱动电压内来操作模块是必要的。超过限定电压会缩短液晶寿命。直流电会引起液晶的电化学反应，导致液晶老化，因此要避免直流电驱动液晶。

4.4.3 Response time will be extremely delayed at lower temperature than the operating temperature range and on the other hand at higher temperature LCD's show dark color in them. However those phenomena do not mean malfunction or out of order with LCD's, which will come back in the specified operating temperature.

液晶响应时间在低温时比常温要慢，高温时，液晶底色会深。然而，这并不是指液晶显示屏工作异常，显示屏在温度恢复时，效果会恢复正常。

4.4.4 If the display area is pushed hard during operation, the display will become abnormal. However, it will return to normal if it is turned off and then back on.

如果在运行过程中显示区受到挤压，显示将会异常。然而挤压中断，将恢复正常。

4.4.5 A slight dew depositing on terminals is a cause for electro-chemical reaction resulting in terminal open circuit. Usage under the maximum operating temperature, 50%RH or less is required.

接线端冷凝会引起电化学反应而断路。因此必须在最大的操作温度之内，湿度小于50% 的条件下使用液晶显示模块。

4.4.6 Input logic voltage before apply analog high voltage such as LCD driving voltage when power on. Remove analog high voltage before logic voltage when power off the module. Input each signal after the positive/negative voltage becomes stable.

开机时，先让逻辑电压，再接通模拟高压，如显示屏驱动电压。关机时，先断开模拟高压，再关逻辑电压。正负电源都稳定后再送控制信号。

4.4.7 Please keep the temperature within the specified range for use and storage. Polarization degradation, bubble generation or polarizer peel-off may occur with high temperature and high humidity.

模块在操作和存储规格范围内使用。高温高湿可能会引起偏振退化，起泡，偏光片脱落等问题。

#### 4.5 Safety 安全

4.5.1 It is recommended to crush damaged or unnecessary LCDs into pieces and wash them off with solvents such as acetone and ethanol, which should later be burned.

建议将损坏的液晶显示屏压成碎片，用溶剂诸如丙酮，乙醇冲洗掉，迟后烧掉。

4.5.2 If any liquid leaks out of a damaged glass cell and comes in contact with the hands, wash off thoroughly with soap and water.

如果任何液体从液晶盒泄漏出且与手接触，要用肥皂和水彻底清洗。

#### 4.6 Limited Warranty 有限责任

Unless agreed between TRULY and the customer, TRULY will replace or repair any of its LCD modules which are found to be functionally defective when inspected in accordance with TRULY LCD acceptance standards (copies available upon request) for a period of one year from date of production. Cosmetic/visual defects must be returned to TRULY within 90 days of shipment. Confirmation of such date shall be based on data code on product. The warranty liability of TRULY limited to repair and/or replace on the terms set forth above. TRULY will not be responsible for any subsequent or consequential events.

除信利和客户之间另有协议外，自生产之日起一年内，根据信利的液晶显示屏品质标准，信利将对有功能缺陷的液晶显示模块换货或返工。

外观/视觉缺陷产品，必须在出货后90天内归还信利。以产品上标识日期为准。信利保修责任仅限于对符合上述规定的货品进行返工和/或换货。对此后发生的任何情况，信利均不承担任何责任。

#### 4.7 Return LCM under warranty 模块保修

4.7.1 No warranty can be granted if the precautions stated above have been disregarded. The typical examples of violations are :

保修是以上述注意事项未被忽视为先决条件的。典型的违反例子如下：

4.7.1.1 - Broken LCD glass.

-断裂的液晶显示屏玻璃。

4.7.1.2 - PCB eyelet is damaged or modified.

-印制线路板孔修改或损坏。

4.7.1.3 -PCB conductors damaged.

-线路板导体损坏。

4.7.1.4 - Circuit modified in any way, including addition of components.

-线路随意变更，包括元件变化。

4.7.1.5 - PCB tampered with by grinding, engraving or painting varnish.

-印制电路板已修改，如研磨，雕刻，绘涂等。

4.7.1.6 - Soldering to or modifying the bezel in any manner.

-焊接或变动模块

4.7.2 Module repairs will be invoiced to the customer upon mutual agreement. Modules must be returned with sufficient description of the failures or defects. Any connectors or cable installed by the customer must be removed completely without damaging the PCB eyelet, conductors and terminals.

模块维修清单将按双方协议送呈客户。模块详细缺陷描述须模块一并退回。顾客安装的连接器或电缆必须在不破坏线路板孔，线路和引线端条件下全部移去。

**■ PRIOR CONSULT MATTER****提前商议事项**

- 1 For Truly standard products, we keep the right to change material, process ... for improving the product property without prior notice to our customer.  
对于信利的标准产品，我们保留在不通知客户的情况下,为提高产品性能而改变原材料及加工方法等的权利。
- 2 For OEM products, if any changes are needed which may affect the product property, we will consult with our customer in advance.  
对于 OEM 产品，如果需要做任何会影响到产品性能的改变，我们会提前和客户商议。
- 3 If you have special requirement about reliability condition, please let us know before you start the test on our samples.  
如对可靠性条件有特殊要求，请在模块测试前通知我们。

**■ FACTORY CONTACT INFORMATION****工厂联系信息****FACTORY NAME:** TRULY SEMICONDUCTORS LTD.

工厂名称:信利半导体有限公司

**FACTORY ADDRESS:** Truly Industrial Area, ShanWei City,GuangDong,China

工厂地址: 中国广东省汕尾市信利工业城

**P.C:** 516600 **URL:** <http://www.truly.com.hk> <http://www.trulysemi.com>邮政编码: 516600 : 网站:<http://www.truly.com.hk> <http://www.trulysemi.com>